



C42

Owner's Manual

OHB/C42/001

Issue 14

C42 Owner's Manual

FLIGHT, OPERATION AND MAINTENANCE MANUAL

This Manual belongs to aircraft reg: **G-XXXX**

Type: **IKARUS C42 FBXX/XX**

Serial No: **XXXX-XXXX**

Series Build Aircraft

Microlight Aircraft Types: **IKARUS C42 FB80, C42 FB100 *******

Type Approval Data Sheet (TADS) No. **BM 68**

Manufacturer:



Red-Air UK

Hangar 6
Wolverhampton Halfpenny Green Airport
Bobbington
Stourbridge
West Midlands
DY7 5DY

Tel. +44 (0)1384 221600

Email: sales@red-air.co.uk

Web: www.red-air.co.uk









CAA Company Approval No DAI/9949/11

This handbook should be kept with the aircraft.

CONTENTS

	Page
CONTENTS	3
ISSUE AMENDMENTS	4
Preamble	5
SECTION 1 - AIRFRAME AND ENGINE LIMITATIONS.....	6
SECTION 2 - OPERATIONAL LIMITATIONS	9
SECTION 3 - OPERATION OF THE POWERPLANT	10
SECTION 4 - FLIGHT	11
SECTION 5 - MINIMUM REQUIRED EQUIPMENT:	16
SECTION 6 - WEIGHT AND BALANCE	17
SECTION 7 - DATA PLACARDS	19
SECTION 8 - CHECKLISTS	24
SECTION 9 - FLIGHT PERFORMANCE.....	26
SECTION 10 - DESCRIPTION OF SYSTEMS.....	27
SECTION 11 - INSPECTION AND MAINTENANCE	33
SECTION 12 - WING RIGGING AND DE-RIGGING, FLYING WITH DOORS REMOVED.....	36
SECTION 13 - SETTING (RIGGING) AND MISCELLANEOUS DATA	40

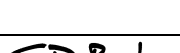
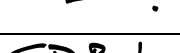
ISSUE AMENDMENTS

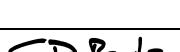
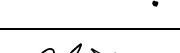
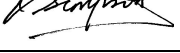
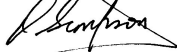
Issue No.	Change/Description	Date	Signature
1	Derived from Draft 3, format was A5; 7.1, placards were on dash.	3/10/03	
2	Format change only	30/10/03	
3	Tyre pressure change	05/05/04	
4	Warp Drive 3 blade prop – 80hp Version	22/06/04	
5	50 hour Inspection schedule Change (Item 7 Stub Axle) Format change from CTP	29/09/04	
6	Significant changes to flight sections by Paul Bennett C.T.P. 65 litre fuel tank option.	08/12/04	
7	Company name change.	24/03/05	
8	Flying with doors removed & tyre pressure change Neuform fixed pitch prop 100hp version.	16/09/05	
9	Neuform fixed pitch prop 80hp version. Neuform variable pitch prop 100hp version. Seat weight limit increase. Weight and balance loading plan change. Checklists and inspection schedules altered.	15/11/05	
10	Disabled hand rudder controls and wheelchair stowage.	15/09/06	
11	B model information added (carburettor heat and oil/water heat exchanger). Company name change.	24/11/10	
12	472.5kg weight data. Beringer brakes, Kiev Prop, and BRS information. Company name change.	03/03/11	
13	Galaxy GRS information added.	18/03/11	
14	Kiev Prop for Rotax 912UL 80hp added.	07/04/11	

IKARUS C-42 FLIGHT AND OPERATOR'S MANUAL

Preamble

A record of all amendments is to be found in the front of this manual.

The C42 aircraft is a Microlight, conforming to the definition within BCAR Section S, 1999. To operate the aircraft the pilot must hold at least a minimum of a Microlight PPL. The aircraft is not to be flown unless it is registered, carries registration markings in accordance with the CAA requirements, and has a valid Permit to Fly. The aircraft is to be flown under daytime VFR conditions only.

All Group A (conventional light aircraft) rated pilots should be checked out by an approved instructor prior to flying this aircraft as it possesses characteristics that are unique to Microlight type aircraft. These characteristics include low inertia, susceptibility to turbulence and wind gradient and special engine considerations.

If the Neuform Variable Pitch propeller is fitted then documents reference NAM/C42/001 and NOM/C42/001 must be considered part of this Owner's Manual.

If the disabled hand rudder controls are fitted then document reference DRC/C42FBUK/03 must be considered part of this Owner's Manual.

If the wheelchair stowage modification is fitted then document reference C42/030 must be considered part of this Owner's Manual.

If Beringer brakes are fitted then the Beringer Maintenance Manual must be considered part of this Owner's Manual.

If a Ballistic Recovery System is fitted then the Ballistic Recovery System Operation and Maintenance manuals must be considered part of this Owner's Manual.

The engine of this aircraft is not certified, and could fail at any time. For this reason NEVER fly over congested areas or other areas on to which a safe landing cannot be made in the event of an engine failure. On cross country flights, ALWAYS keep an emergency landing field in sight.

Changes to the control system, structure, wings and engine are prohibited.

All operating difficulties and equipment failures should be reported to Performance Aviation Ltd.

SECTION 1 - AIRFRAME AND ENGINE LIMITATIONS

Airspeeds - all speeds are Indicated Air Speeds (IAS).

V _{NE} , Never Exceed Speed:	139 mph, 121 kt
V _A Max. manoeuvring speed,	94 mph, 82 kt
V _{SO} Stall speed, full flaps:	37 mph, 32 kt
V _{S1} Stall speed, flaps retracted:	47 mph, 41 kt
V _{FE} Max speed :	72 mph, 63 kt

V_{NE} & V_A limitations are affected when flying with doors removed Aerosport MOD C42/019

VNE (Velocity Never Exceed): 103 mph, 90 kt.

VA (Maximum Speed for Full Deflection of Controls / Rough Air): 80 mph, 70 kt.

Weights:

Empty weight (max):	265.5 kg 100 hp 912S 268 kg 80hp 912
Max gross weight:	450 kg.

With 472.5kg MTOW Performance Aviation MOD C42PAUK/001 and Ballistic Recovery System
Performance Aviation MOD C42PAUK/003 or C42PAUK/006:

Empty weight (max):	288 kg 100 hp 912S 290.5 kg 80hp 912
Max gross weight:	472.5 kg.

Areas:

Wing area	135 sq ft, 12.5 sq.m
-----------	----------------------

Structural limitations:

Positive limit load	4g (at all speeds)
Negative limit load	-2g

Centre of gravity limits: (Zero datum at the wing leading edge root)

Forward centre of gravity	350 mm aft of datum (366mm at M>450kg).
Rearward centre of gravity	560 mm aft of datum.

Airspeed markings:

White Arc:	37 to 72 mph (32 to 63 kt) —full flap operating range.
Green Arc:	47 to 94 mph (41 to 82 kt) — normal operating range.
Yellow Arc:	94 to 139 mph (82 to 121 kt) CAUTION, DO NOT USE IN TURBULENCE.
Red Line:	139 mph (121 kt) V _{NE} VELOCITY NEVER EXCEED.
Yellow Triangle:	60 mph, 52 kt - Recommended Minimum Approach Speed

Control Deflection Limits

At V_{NE} control surfaces should not be deflected more than one third full range.

V_A is the maximum speed permitted in turbulent conditions. Full deflection of the controls at speeds above V_A is prohibited.

Slight adjustment to the pitch of each of the above propellers may be necessary to obtain the correct ground static rpm. An optical tacho on the propeller is the preferred method of measuring the engine speed.

Engine

According to ROTAX Manual:

Oil Pressure:		2 - 5 bar
Oil Temperature:	min.	50° C
	max.	140° C (80hp), 130° C (100 hp)
	preferred range	90 - 110° C

Maximum coolant temperature 115°C

Maximum Cylinder Head Temp. (CHT)	
912 (80hp)	150°C
912S (100hp)	135°C

Above CHT and coolant temperatures assume 50% glycol/water coolant mixture.

Ballistic Reserve Parachute Systems

Junkers Magnum Light Speed Softpack:

Maximum operating speed	162kt, 186mph, 300kph
Maximum operating weight	475kg

Galaxy GRS 5/472.5:

Maximum operating speed	136kt, 157mph, 251kph
Maximum operating weight	472.5kg

Occupant Warning - The parachute recovery system installation has been approved by BMAA on the basis that, as far as is practicable to demonstrate, it will create no hazard to the aeroplane, its occupant(s) or ground personnel whilst the system is not deployed; and that when properly maintained, the risk of malfunction, deterioration or inadvertent deployment is minimised. The BMAA has not approved the system itself or considered the circumstances, if any, in which it might be deployed. The effectiveness of the system for the safe recovery of the aeroplane has not been demonstrated.

SECTION 2 - OPERATIONAL LIMITATIONS

This aircraft

- must not be flown in aerobatic manoeuvres.
- must not be flown at bank angles beyond 60 degrees.
- must be flown under daylight, VFR conditions only.
- must not be flown in known airframe icing conditions.
- must not be flown in conditions of moderate turbulence or above, or in winds exceeding 22 kts, at surface level, less if gusty.

Always follow the appropriate regulations for this category of aircraft.

Permitted Manoeuvres

Non-aerobatic operation only.

Any manoeuvre necessary for normal flight.

Stalls.

Steep turns with bank angles not exceeding 60°

Placarded limitation must be observed at all times. Additionally pilots should only fly in conditions which are compatible with their own ability.

Maximum permitted dry empty weight:	100 hp 912S	265.5 kg
	80 hp 912	268 kg

With 472.5kg MTOW Performance Aviation MOD C42PAUK/001 and Ballistic Recovery System
Performance Aviation MOD C42PAUK/003 or C42PAUK/006:

Maximum permitted dry empty weight:	100 hp 912S	288 kg
	80hp 912	290.5 kg

SECTION 3 - OPERATION OF THE POWERPLANT

Description:

The Rotax 912 and 912S are 4 cylinder, four stroke, horizontally opposed engines. They are cooled by a combination of air-cooled cylinders and liquid cooled heads. The engine oil is also air-cooled with a small radiator.

The B Model aircraft utilise an oil/water heat exchanger in place of the oil radiator. A carburettor heat control is also fitted which draws air from around the exhaust, via the usual air filter. This should only be activated if carburettor icing is suspected (see Emergency Procedures section).

Fuel Type: Min 91 Octane for the 80 hp, Min. 95 Octane for the 100 hp engine (RM/2 method) automotive gasoline leaded or unleaded or AVGAS 100 LL . Prolonged use of AVGAS can cause damage to the Rotax 912, precludes use of fully synthetic oil and requires more frequent oil and oil filter changes. Please study the Rotax engine operating manual.

CAUTION: Never handle the propeller with the ignition on.

To Start:	Main fuel valve,	OPEN
	Master switch	ON
	Electric fuel pump	ON
	Throttle at idle	FULL AFT
	Brakes	ON
	Mags (both)	ON
	Propeller area	CLEAR
	Rear of aircraft	CLEAR
	Choke (pulled out)	ON Start
	After engine starts, choke	OFF
	Check:	OIL PRESSURE RISING.

Note: If the engine doesn't start, repeat the procedure. If the engine floods, close the main fuel valve, half open the throttle and turn over the engine. When it starts, reduce the throttle quickly to idle (2000 rpm) and turn on the fuel.

Open the main fuel valve - don't forget!

Note: A water-cooled four stroke engine requires a fairly long warm up period. Run the engine at 2000 rpm for 2 minutes minimum then at 2500 rpm until the oil temperature is at least 120°F (50° C). Perform an ignition system check at 3500 rpm by turning off each ignition switch in turn. The engine speed drop should not exceed 300 rpm with a maximum difference of 120 rpm.

Failure to let the oil temperature reach 50°C can result in carburettor ice forming during takeoff. It is imperative that this procedure is followed otherwise serious injury or death may result.

SECTION 4 - FLIGHT

4.01 Taxiing:

The nose wheel steering is conventional and is directly connected to the rudder pedals. Push the right pedal to turn right. Push the left pedal to turn left. Taxiing is simple; the turning radius of the C42 is small, and the aircraft handles cross winds during taxiing very well.

When taxiing with a strong tail wind, hold the control stick firmly in the neutral position.

When taking off or landing on bumpy grass strips, exercise caution to avoid striking the propeller. This may require performing soft field take-off and landing procedures.

Note: with a fully aft cg it is possible for the aircraft to tip back and sit on its tail skid, particularly if taxiing over uneven ground.

4.02 Takeoff and climb:

Complete the pre-take checklist 'VITAL ACTIONS'. Ensure the trim is set to one step above neutral, as indicated by a centre-scale reading on the trim indicator and the flaps are set as required (Max 1 stage, 15 degrees). Always take off into the wind when possible. The maximum demonstrated 90 degree crosswind component is 17 mph (15 knots).

The stick position should be positively aft of neutral and maintained during the ground roll to minimise the loading on the nose wheel. Smoothly bring the throttle to the full forward position, check the tachometer for full throttle rpm.

It will be necessary to hold right rudder to counteract slipstream effect and engine torque during the ground roll and climb out. The nose wheel lifts off at approximately 30 mph, (26 kt). Accelerate with the nose wheel off the ground 2-4 inches, (5-10 cm). The aircraft will take off at 44 mph (38 kt).

After takeoff, let the aircraft accelerate to the best rate of climb speed V_y 70 mph, (60 kt), 1 stage flap extended. At between 150 and 200 ft raise the flaps to the cruising flight position (0 degrees or no flaps). Be ready for the pitch trim change to nose-down. Trim the aircraft as required for the climb. Recommended full power climb 80 hp 62 - 66 kts. Recommended full power climb 100 hp 66 - 70 kts.)

Best angle of climb speed V_x is 55 mph, (48 kt) (1 stage flaps). However this climb speed and angle are not recommended because in the event of an engine failure it is possible that control of the aircraft may be lost. The aforementioned procedure is therefore recommended. This should ensure full control is maintained in the event of an engine failure shortly after takeoff providing immediate engine failure action is taken.

Cross wind take off :

Take off should be made as described above but with into wind aileron. Maintain track down the centreline with rudder and further maintain into wind aileron as required to stop your drift during the take off roll and rotation. (Out of wind wing main wheel can lift off first during take off). Resume wings level balanced flight after take off.

The maximum demonstrated 90 degree cross wind component is 17 mph (15 kts)

4.03 Cruising flight:

Note: Typical economic cruise speeds lie in the range 80 to 105 mph (70 to 90 kt); 109 mph (95 kt) with the 100 hp engine.

Maximum continuous engine speed is 5500 rpm for the 80 hp 912, and 5300 rpm for the 100 hp 912S.

Variations in rpm and cruise performance occur with different loads.

Typical cruising flight (80 hp)

Engine speed:	4500 rpm.
Airspeed:	95 mph (83 kt)
Fuel flow:	2.8 Imp. gallons per hour, (12.7 l/h)

The maximum speed in cruising flight is 118 mph (103 kt).

Note: ***This maximum speed applies only in smooth conditions with no turbulence. In turbulent air, speed must be kept below $V_A = 94$ mph (82 kt).***

4.04 Turning flight:

In turning flight, it is necessary to co-ordinate the use of the ailerons and the rudder. At normal cruising speeds 80 mph (70 kts) to 103 mph (90 kts) initiate the turn with aileron maintaining balance as necessary with rudder. At bank angles exceeding 45 degrees the pitch trim force required to maintain level flight increases noticeably. Banks exceeding 60 degrees are prohibited. In steep bank turns remember to maintain the attitude at entry and maintain airspeed with power. Failure to maintain correct attitude can result in a spiral dive developing. At 60 degrees of bank the stall speed is multiplied by a factor of 1.41 and you will be pulling 2g.

4.05 Slow flight, stalling and use of flaps:

In cruising flight configuration with the landing flaps retracted and at speeds below 60 mph (52 kt) the top of the engine cowl will be well above the horizon. Control inputs of the aileron and rudder will be severely dampened and the overall response of the aircraft markedly reduced. Only gentle turns should be made of up to 20 degrees of bank ensuring the aircraft remains in balance. In slow flight if a wing drops, centrally reduce back pressure on the stick and lower the nose. Prevent further yaw with the rudder and do not attempt to lift the wing by aileron input.

At approximately 48 mph (42 kt) there will be a slight buffeting of the airframe. The aircraft is still controllable. However, aileron input should not be used and the stick kept central with any tendency for the wing to drop use opposite rudder to prevent yaw.

If stalls are entered very gently the aircraft can enter a controlled mushing descent, control can still be maintained with rudder. (It is important not to over use rudder and potentially put the aircraft into a reverse spin entry).

When the aircraft stalls the nose will drop. By removing back pressure the aircraft should recover. Typical height loss in the wings-level stall is approximately 100 ft., and max. Pitch attitude change 25° below the horizon. In turning flight stalls the typical height loss is 120 ft. At full flap (40 degrees) the pre-stall buffet, 39 mph (34 kts), is markedly more noticeable and there is an increased tendency for the wing to drop if balanced flight is not maintained.

Speeds are as follows:

VS1 flaps retracted (0°) 47 mph, (41 kts)

VS2 first notch of flaps (15°) 42 mph, (36 kts)

VS0 full flaps (40°) 37 mph, (32 kts)

The above specified stall speeds will vary slightly depending on the all up weight.

Spinning

Spin recovery – Immediately fully close the throttle. If full flap is set raise the flaps otherwise leave. Apply rudder opposite to the direction of rotation until rudder is centralised and then release back pressure from the stick. If the spin continues apply full opposite rudder then move the stick forward until the spin stops.

Avoid over speeding the aircraft during the pull out.

4.06 Descents, landing and roll out:

Entering a conventional circuit in the cruise 92 mph (80 kts) when on the base leg reduce power, maintaining attitude allowing a reduction in airspeed to 72 mph (63 kts) (white arc) select 15 degrees flap (1 stage) simultaneously lowering the nose to maintain 67 mph (58 kts) and trim.

On final approach if the crosswind component is less than 12 mph (10 kts) you can select full flaps simultaneously lowering the nose to maintain 55 kts. Continue your approach at 63 mph (55 kts) and trim if required. Minimum approach speed in this configuration is 60 mph (52 kts).

In calm conditions it is acceptable to use side slip technique to increase your rate and angle of descent, but it is recommended the aircraft is returned to a standard approach configuration before reaching 100 ft above the runway.

In the landing phase during the hold off when the main wheels touch ensure that the nose wheel is maintained clear of the runway during the landing roll bringing the stick steadily rearward until it reaches the backstop and allow the nose wheel will settle onto the runway as the speed decays.

Caution should be exercised when applying brakes as it is possible to lock the main wheels under certain conditions. It is preferable to allow the aircraft to de-accelerate to a walking pace before applying any braking action.

Cross wind landing technique

Establish the aircraft on a powered approach, tracking the centreline and allowing for drift. For crosswind components of 12 mph (10 knots) or above only 1 stage of flap (15 degrees) is recommended. Approach speed should be 66 mph (58 kts).

The generic wing down approach is recommended. If you are not fully aware of crosswind techniques you should consult an approved instructor. The following description is for guidance and not a substitute for proper instruction.

Below 200 feet on the approach, apply rudder to align the nose of the aircraft with the centreline of the runway simultaneously lowering the into-wind wing with aileron to maintain your track down the centreline (preventing drift).

Smoothly allow the aircraft to settle on to the runway, the into wind wheel will contact the runway first maintaining directional control with the rudder and progressively increase the into-wind aileron deflection as the airspeed reduces.

Allow the nose wheel to settle on to the ground earlier than normal to transfer steering authority. Avoid "fully holding off" before touchdown as drift angle increases and airspeed decays, the control authority also reduces.

4.07 Shutting down the engine:

During the descent and subsequent taxiing, the engine will have cooled down enough to permit immediate shut-down after parking.

Turn off all electrical accessories and radios before shutting down the engine.

4.08 Sudden loss of engine power:

Set attitude for best glide at 58 kts and trim (This is a good compromise speed and easy to achieve quickly). Assess the wind direction and select a suitable landing area into wind. Plan your approach and execute this action.

If you have time check the reason for engine failure:

***Master switch ON
Magnetos switches ON
Fuel tap ON
Choke OFF***

Try restart:

***Auxiliary fuel pump ON
Throttle set 1/4 open
Press starter***

If restart not achieved and you still have sufficient height and time make a MAY DAY call. Stay on the frequency you are already on if contact established. Remember it is more important to keep flying the aircraft on your planned approach than any other action.

Do not turn your back on the planned landing site or make a 360 degree. A constant aspect approach is recommended coupled with beats and turns and or sideslip to increase rate of descent.

IMPORTANT: SHUT DOWN CHECKS (Prior to landing)

***Throttle closed
Master OFF magnetos OFF
Fuel OFF
Security - harnesses tight, reassure passenger***

1 Stage of flap can be applied at any time during your descent.

During your initial approach you should be aiming at the middle of the landing site bringing your aiming point back to one third in after applying full flap. All emergency landings should be made into wind with full flap to minimise landing speed.

Remember - KEEP FLYING THE AIRCRAFT AT ALL TIMES.

4.09 Emergency procedures:

- I Should you lose elevator control due to a mechanical failure, trim the aircraft to 65 mph (56 kt). With a reduced power setting, make a shallow power-on landing approach, throttle back and flare using the trim. Avoid use of the flaps.
- II If you lose aileron control, you can fly the aircraft with rudder alone.
- III If you lose rudder control, the aircraft can be flown with the ailerons alone.
- IV In the event of carburettor or engine fire:
 - Main fuel valve off .
 - Electric fuel pump off.
 - Full throttle, (to burn the remaining fuel fast).
 - Maximum permissible airspeed to put out the flames.
 - Call MAYDAY
 - Follow emergency landing procedures.
- V **B Model only:** if carburettor icing is suspected, with symptoms such as rough running, activate the carburettor heat control. An rpm drop of around 100-150rpm is expected, with a small reduction in power. If rpm increases within 1-2 minutes carburettor icing was likely to have been occurring and the carburettor heat control should be left on for the remainder of the flight. Use of the carburettor heat control at other times is not recommended.
- VI **Ballistic Recovery Parachute equipped aircraft only:** if the pilot-in-command decides to deploy the parachute in an emergency situation he should do so without delay, before height is lost or speed becomes excessive.

As the operation of these systems is not guaranteed, and system failure may place the aircraft in a more dangerous situation than the initial problem, consideration should be given before flight to the situations in which you personally, as the pilot-in-command, would make the decision to deploy the parachute.

Such occurrences may include mid-air collision, structural failure, pilot incapacity, or engine failure over terrain unsuitable for forced landing (note the latter is preventable by sensible piloting).

Note that if a forced landing has a reasonable chance of being accomplished safely it is the generally accepted course of action.

To deploy the parachute:

- Switch off engine
- Pull handle firmly (extension about 25 mm on Junkers, up to 100mm on GRS)
- If time available, retighten seat belts
- Protect face and body with your arms
- Press into seat by extending your legs

Refer to Operators Manual supplied with system and appended to this Owner's Handbook for details.

SECTION 5 - MINIMUM REQUIRED EQUIPMENT:

- a. Four point harness.
- b. Airspeed indicator 0-150 mph (0 - 130kt)
- c. Altimeter.
- d. Data placard and weight and balance document.
- e. Pre flight check list.
- f. Tachometer
- g. Cylinder head temp. or coolant temperature gauge.
- h. Oil pressure gauge
- i. Oil temperature gauge

SECTION 6 - WEIGHT AND BALANCE

6.1 Weight and Balance Calculations

The centre of gravity is measured in mm behind the zero datum. Zero datum is the leading edge root.

The aircraft's empty weight and cg are derived first: Place the aircraft in a level position on three scales, such that the stabilizer is horizontal, as shown below. Push down on the rear fuselage, just in front of the tail, and chock the nose wheel to level the aircraft. Record the reading of each scale.

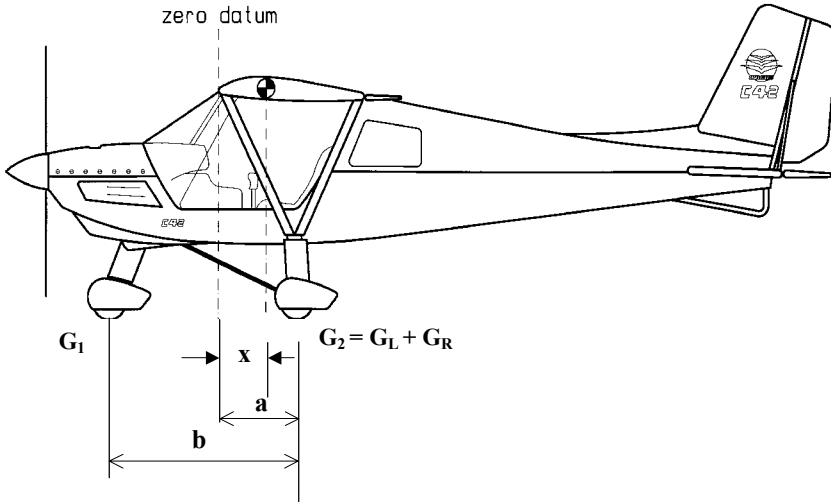

Calculate the position of the empty cg, from the formula:

$$X = a - \frac{G_1 \times b}{G_1 + G_2} = \dots\dots\dots mm$$

(a and b are values to be measured for the specific aircraft).

Insert the values for total empty weight, $(G_1 + G_2)$ and cg distance aft of datum, (X) , into the table below. Multiply Empty Weight (kg) by cg distance aft of datum (mm) to derive empty weight moment (kg.mm) in the last column.

Complete the remaining weights for seat loads, fuel and baggage and multiply these by the lever arm lengths (given below).

Add up the weights and moments, then divide the total weight by the total moment to give laden cg location aft of datum.

Ensure that this cg location lies within the limits 350 to 560 aft of datum.

For operation at weights over 450kg, the forward limit is 366mm aft of datum. This is a limitation to remain within tested nose wheel loads.

Loading plan

Position	weight	x	lever arm	=	moment
	kg		mm		kg.mm
Empty weight					
1. Seats			400		
2. Under seat bags			400		
3. Fuel			950		
4. Samsonite case			950		
Total Weight		kg	Total Moment		kg.mm
centre of gravity CG =		$\frac{\text{Total Moment}}{\text{Total Weight}}$		=	mm

6.2 Conditions of Weighing

The dry empty weight of the aircraft is defined under the following conditions:

- All normal installed equipment fitted.
- Oil and coolant levels normal.
- No usable fuel.

Note: Remaining within the maximum Take-off Weight (MTOW) of 450 kg (or 472.5kg with appropriate modifications fitted) is the pilot's responsibility.

SECTION 7 - DATA PLACARDS

The following placards are fitted to the aircraft, in the locations indicated:

7.1 In View of the Pilot:

For the 100hp:

V _{NE}	139 mph (121 kt)
V _{FE}	72 mph (63 kt)
RPM max. (5 mins)	5800 rpm
RPM max. continuous	5300 rpm
Oil pressure	2 – 5 bar
Oil Temp.	Min. 50°C
Oil Temp.	Max. 130°C
CHT	Max. 135°C

For the 80hp:

V _{NE}	139 mph (121 kt)
V _{FE}	72 mph (63 kt)
RPM max. (5 mins)	5800 rpm
RPM max. continuous	5500 rpm
Oil pressure	2 – 5 bar
Oil Temp.	Min. 50°C
Oil Temp.	Max. 140°C
CHT	Max. 150°C

Flying Without Doors: Aerosport MOD C42/019

Flying Without Doors Aerosport MOD C42/019
V _{NE} 103 mph (90 kt)
V _A 80 mph (70 kt)

Neuform Variable Pitch Prop: Aerosport MOD C42/007

Propeller Pitch Control Aerosport MOD C42/007
Lever Forward – Fine
Lever Aft - Coarse

7.2 Secondary Control Markings

The following secondary controls are marked for function and operation:

Trim - next to the trim rocker switch.

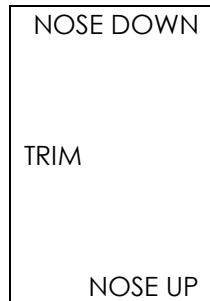

Flaps - next to the flaps control lever:

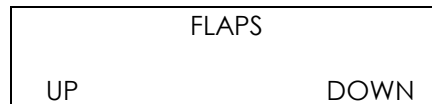

Fuel Tap - next to the fuel tap:

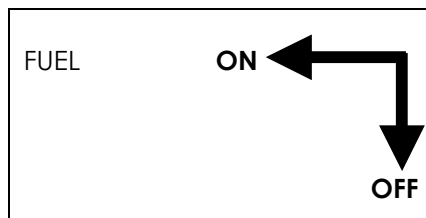

Starter - next to the starter button



Choke - next to the choke:



Carburettor Heat - next to the carburettor heat knob (B model only):



7.3 Fuel Filler - next to the fuel filler:

For the 100 hp Rotax:

Unleaded MOGAS
Minimum Fuel Grade
MON 85, RON 95, AKI 91
AVGAS 100LL
Avoid prolonged use of Avgas

For the 80 hp Rotax:

Unleaded MOGAS
Minimum Fuel Grade
MON 83, RON 91, AKI 87
AVGAS 100LL
Avoid prolonged use of Avgas

7.4 Oil Filler - near the oil filler:

Use synthetic or semi-synthetic oil.
Specification API SG, SF or higher.
See Rotax manual for oil
recommendations

7.5 Fuel Tank – near the fuel filler (50, 65 or 100 litre option)

Usable fuel capacity 50 litres

Usable fuel capacity 65 litres

Usable fuel capacity 100 litres

7.6 Loading: Within pilots view

Empty weight	
Date of Weighing	
Max. weight	450 kg
Max cockpit load	172 kg
Min. cockpit load	55 kg
Max weight per seat	120 kg
Max. permitted fuel at max. cockpit load	
Max. permitted cockpit load with max. fuel	

Or with 472.5kg MTOW Performance Aviation MOD C42PAUK/001 and Ballistic Recovery System Performance Aviation MOD C42PAUK/003 or C42PAUK/006:

Empty weight	
Date of Weighing	
Max. weight	472.5 kg
Max cockpit load	172 kg
Min. cockpit load	55 kg
Max weight per seat	120 kg
Max. permitted fuel at max. cockpit load	
Max. permitted cockpit load with max. fuel	

Wheelchair Stowage
Aerosport Mod C42/030

Max cockpit load
reduced to 160.5 kg
with wheelchair fitted

7.7 Occupant Warning – Within occupants' view

This aircraft has not been certified to an international requirement. Aerobatics and spinning prohibited. Flight by day and in VFR only. Smoking prohibited.

7.8 Unleaded Fuel Warning – Within pilot's view

USE OF UNLEADED MOGAS
(See Airworthiness Notice 98B & C)
* Only legal in aircraft specifically approved for the purpose.
* Fuel to be fresh, clean, alcohol and water free.
* Check for leaks and deterioration of pipes, fittings, valves.
* Verify take-off power prior to committing to take-off.
* Tank fuel temperature not above 20°C.
* Fly below 6000 ft.
CARB ICING AND VAPOUR LOCK MORE LIKELY

7.9 Ballistic Recovery System Warning – Within pilot's view

Occupant Warning
The parachute recovery system installation has been approved by BMAA on the basis that, as far as is practicable to demonstrate, it will create no hazard to the aeroplane, its occupant(s) or ground personnel whilst the system is not deployed; and that when properly maintained, the risk of malfunction, deterioration or inadvertent deployment is minimised. The BMAA has not approved the system itself or considered the circumstances, if any, in which it might be deployed. The effectiveness of the system for the safe recovery of the aeroplane has not been demonstrated.

Close to deployment handle:

WARNING – EMERGENCY PARACHUTE
Pull Handle Firmly to Deploy
Unapproved Equipment - see Pilot's Handbook

On exterior of aircraft, close to parachute breakthrough panel:

DANGER

and:

Ballistic Recovery System
Inside

SECTION 8 - CHECKLISTS

Daily Inspection / Pre-flight Inspection



Daily Inspection: Remove engine cowling and thoroughly inspect engine installation.

Cockpit

- Panel secure, all switches OFF, master key out, instruments normal, glass intact.
- Cockpit area inside and out, check controls full movement, free and correct sense.
- Check aileron quick release connections, cable and pulley runs.
- Lift central flap between seats and check no interference of control lines.
- Check rudder cable attachments and nose wheel control rod attachment.
- Check throttle operation normal.
- Check flap operation normal.
- Check security and operation of seat belts.
- Check under seats and stow loose items.

Outside

- Engine and cowling secure and undamaged.
- Check oil level within limits.*
- Check coolant level correct.
- Propeller clean and undamaged.
- If Neuform Variable Pitch fitted check blade bearing play and check full pitch range movement.
- Check spinner secure and undamaged.
- Check cowling air intakes unobstructed.
- Front gear assembly, tyre pressure, condition and creep.

- Starboard door hinges, gas strut attachments and door lock operation normal
- Starboard main gear assembly, tyre pressure, condition and creep.
- Starboard wing assembly, structure and covering.
- Starboard aileron, control linkage and hinges secure.
- Starboard flap, control linkage and hinges secure.
- Fuel filler cap secure.
- Check fuel quantity.
- Starboard fuselage clean and undamaged.
- Tail group assembly secure and surfaces undamaged.
- Elevator hinges and control linkage secure.
- Trim tab and linkage secure.
- Rudder hinges and control cables secure.
- Check same on port side.
- Remove baggage panel, check no loose items and re-secure.
- ASI pitot unobstructed and fully extended.
- Windscreen clear and undamaged.
- Open fuel tank sump drain and check for contamination.
- Check tank drain for leaks.

**When checking the oil level it may be necessary to pump the oil back into the reservoir to obtain a correct reading and to avoid overfilling. This can be done by removing the oil filler cap and ensuring the master switch and magnetos are off and rotating the propeller ONLY in the operating direction until a gurgling sound is heard from the reservoir tank.*

C42

CHECK LIST



START CHECKS

- Brakes ON facing safe direction, area all clear
- Flaps neutral
- Main fuel tap ON
- All switches OFF, radio, transponder OFF
- *Carb heat OFF
- Master switch ON
- Aux fuel pump ON for 5 secs when cold
- Magnetos ON
- Throttle set and choke if required
- Check area clear
- Shout 'CLEAR PROP'
- START engine set: 2000 rpm, when cold set at 2500 rpm
- Strobe ON
- Check aux fuel pump OFF and choke OFF
- Record Hobbs reading and time
- Radio ON transponder on standby

DURING TAXI

- Check brakes, slip ball and compass

PRE FLIGHT (VITAL ACTIONS)

- Park into wind
- Brakes on and locked
- Set throttle at 2000 rpm (when cold set 2500 rpm)
- Controls full and free and correct sense
- Harnesses and hatches secure (no light visible at bottom of door)
- Loose items stowed
- Flight instruments set and correct
- Engine temperatures and pressures within limits
- Magneto check at 2500 rpm (max drop 200 rpm)
- Throttle to idle
- Reset throttle to 2000 rpm
- *Carb heat ON
- Fuel ON, Aux fuel pump ON, contents sufficient
- Trim set for take off and flaps set as required
- *Carb heat OFF (should have been on a minimum 15 secs)
- Check all clear for take off
- Check full power during take off roll (min 5000 rpm)

AFTER TAKE OFF

- Flaps neutral above 100 feet
- Aux fuel pump off above 1000 feet
- Engine temperatures and pressures within limits

SPEEDS

- In the climb:
 - Flaps set neutral: 60 kts
 - Flaps set 1 stage: 58 kts
 - Flaps set 2 stage: 55 kts
- In the approach:
 - Flaps set neutral: 60 kts
 - Flaps set 1 stage: 58 kts (xwind +10 kts +)
 - Flaps set 2 stage: 55 kts

*If fitted

ON ROUTE

- Location and heading
- Instruments both flight and engine good
- Fuel sufficient
- Elapsed time, and time remaining
- *Carb heat ON for 15 secs and turn OFF

DOWNWIND / AIRFIELD APPROACH

- Altimeter set to QFE
- Brakes OFF
- Aux fuel pump ON
- Fuel sufficient for go around
- *Carb heat ON
- Engine temperatures and pressures good
- Activity

BASE LEG

- Flaps set 1 stage

FINAL

- Flaps set 2 stage if required
- *Carb heat OFF
- Clear to land

RUNWAY CLEAR

- Flaps up (neutral)
- Aux fuel pump OFF
- Lights OFF

SHUTDOWN

- Brakes ON
- Magneto check at 2000 rpm
- Radio, Transponder, Nav aids OFF
- Throttle to idle
- Aux fuel pump OFF, Lights OFF
- Check Hobbs reading and record time
- Magnetos OFF
- Strobe OFF
- Master switch OFF

*If fitted

EMERGENCY SHUT DOWN

- T** Throttle closed
- I** Ignition and magnetos OFF
- F** Fuel OFF
- S** Security/Harnesses Hatches

EXTREME MANOEUVRE

- H** Height sufficient
- A** Airframe suitable
- S** Security and loose items
- E** Engine temps and pressures
- L** Location
- L** Lookout

C42

CHECK LIST



SECTION 9 - FLIGHT PERFORMANCE

All versions, at 450kg MTOW:

Best climb rate speed (flaps 15 degrees, 1 stage)	70 mph (60 kt)
Min. sink rate at max. AUW (flaps 15 degrees, 1 stage)	450 fpm
Min. sink rate speed	52 mph (45 kt)
VS1 flaps up stall speed	47 mph (41 kt)
VS2 flaps 1 stage (15 degrees)	41 mph (36 kt)
VSo full flaps stall speed	37 mph (32 kt)
Roll rate at Va	±45 degrees in 2 sec's
Landing distance, from 15m fence	205 metres
Fuel consumption	See Rotax data.
Best glide angle	11:1

C42 FB 100 (Rotax 912S, 100 hp)

Take off distance, to clear 15m fence	205metres
Max. climb rate at max. AUW	1000 fpm
V _h max level speed at max. AUW	124 mph (108 kt)

C42 FB80 (Rotax 912, 80 hp)

Take off distance, to clear 15m fence	220metres
Max. climb rate at max. AUW	700 fpm
V _h Max level speed at max. AUW	120 mph (105 kt)

For MTOW of 472.5kg (when fitted with appropriate modifications) the factors recommended in the CAA Safety Sense leaflet 7 "Aeroplane Performance", also detailed in the GASCO takeoff and landing performance calculator, should be followed:

for the 5% weight increase allow an extra 10% distance.

SECTION 10 - DESCRIPTION OF SYSTEMS

The C42 is a simple aircraft whose structures and systems are readily inspected and maintained. However, since some of its systems differ from those found on conventional aircraft; this section should be studied before dismantling, repair or inspection.

10.1 Airframe

Fuselage

A 165 mm diameter aluminium tube runs from nose to tail and carries all the major assemblies: engine, seats, undercarriage, fuel tank, and tail empennage. The cockpit structure, consisting of a thin walled aluminium tube frame, includes a welded aluminium box-section frame at its top to which the wing spars' roots attach, and which provides compression load carry-through for both spars.

The composite seats are supported around their edges by attachment to the cockpit frame. Around the outboard edges of the seats, some of these loads are passed via the composite lower fairing to a lateral beam consisting of a 56mm reinforced box section. The ends of this beam accommodate the wing struts and withstand tension loads from them.

All load carrying (structural) members of the airframe are aluminium alloy tubes; most of which terminate in spherical bearings.

Wing

The wing has a ladder construction comprising leading and trailing edge tubes, connected by compression struts at intervals along its span. The triangulated wing struts, terminating at a fixed point at the top of the undercarriage, brace the wing against fore and aft loads. In normal +g flight these struts are under tension.

In +g flight both leading and trailing edge tubes inboard of the wing struts junctions, experience compression loads from the wing struts, as well as direct bending from lift loads.

The wing, tail empennage and all control surfaces are constructed of thin walled aluminium tubing. They are covered by a reinforced polyester fabric, sewn into complete envelopes and fitting tightly over their frames.

Undercarriage

The tricycle undercarriage has suspension on all wheels and damping on the main wheels. The front fork is directly connected to the rudder pedals. Hydraulic disc brakes operate on the main wheels only.

Main wheels' suspension stiffness can be adjusted by varying the air pressure in the damper units via the valves in their casings. A special high pressure pump is required for this purpose.

10.2 Power Plant

The 80 hp Rotax 912 or the 100 hp Rotax 912S is installed and drives the propeller via a gearbox with a reduction ratio of 2.27:1 or 2.43:1 respectively. Both power plants are flat 4 cylinder, 4 stroke engines with air and oil cooled cylinders and water-cooled heads. Full descriptions of the engine, its performance and maintenance requirements are to be found in the Rotax manual. Engine limitations are given in Section 1.

Propellers

The following propeller types are approved for use:

With the 80 hp Rotax:

Warp Drive CS68 composite 2 blade 68" diameter propeller.
Warp Drive CS68 composite 3 blade 68" diameter propeller.
Arplast Ecoprop 170R 110/3, 3 Blade 170cm diameter composite propeller.
Neuform CR3 3 blade (1,75 m Ø)
Kiev Prop 263/1700 3 blade composite propeller with a 1.70m diameter.

With the 100 hp Rotax:

Warp Drive CS68 composite 3 blade 68" diameter propeller.
Arplast Ecoprop 170R 3 blade propeller with a diameter of 170 cms (67")
GSC Tech-III 3 Blade 68" diameter wooden propeller.
Neuform CR3 3 blade (1,75 m Ø)
Neuform CR3-V-R2H 180cm diameter variable pitch propeller.
Kiev Prop 283/1800 3 blade composite propeller with a 1.80m diameter.

All approved types, except the Neuform Variable Pitch Propeller, have blades with ground-adjustable pitch and are set to the pitch angles given in Section 1. This pitch angle is prescribed at a specific radius from the point at which the blade exits from the hub.

The propellers have aluminium alloy hubs machined to close tolerances. This permits secure clamping of the blade roots under the high centrifugal forces experienced by the blades in service. Proper blade root securing bolt tension is essential to maintain this security.

Warp Drive and Arplast propellers blades are moulded in composite material, either carbon or glass fibre in epoxy resin. Blades of this type carry all of their strength and rigidity in the external skin, which is carbon or glass fibre braid or fabric. See Section 11.

Exhaust system

The engine is fitted with a Hagerman Exhaust and Silencer System. This system is built largely from stainless steel components.

Fuel Capacity

The C42 has either a 50 litre or 65 litre fuel tank as standard. Both fuel tanks are inter-connectable so fitting an additional tank doubles the capacity to 100 litres or 130 litres. This capacity is placarded next to the filler cap.

10.3 Control Systems

Pitch

A central control stick, accessible by both occupants, is located over the fuselage between the seats. Fore and aft movement of this stick is transferred, via longitudinal push tubes, to a motion reversal lever installed midway between the cockpit and tail. This installation also accommodates the pitch stops. A second push tube, of similar length, runs from this lever to the elevator horn. A rearward movement of the stick lifts the elevator; forward movement depresses it.

Each push rod terminates in a spherical bearing (Rose joint) maintaining loads through the centres of the tubes. The threaded roots of these fittings can be susceptible to failure if bending loads are applied; it is important to ensure complete freedom of the joints at extremes of their movements, such that bending loads cannot be applied.

Roll

The stick is also connected to a torque tube mounted on top of the fuselage tube between the seats, and turning on a Rose joint at each end. The rear of the torque tube carries a pair of horns from which run control cables, one for each side. These cables are led behind and over the cockpit, via pulleys, to a central bellcrank. From here, motion is transferred via push tubes to a bellcrank in each wing, mounted on a wing compression strut forward of the aileron. A second tube links this bellcrank to the aileron horn.

The geometry of the aileron control system produces some asymmetry in the deflections of the ailerons, effectively eliminating adverse yaw.

Movement of the stick to the right results in a lifting of the right hand aileron and depression of the left, and vice versa.

Yaw

Dual rudder pedals are mounted on common torque tubes, bearing in bushes installed directly into the fuselage tube. Control cables run from points near the top of the pedals' arms direct to the rudder horns.

Push rods connected to arms on the font fork, permit direct steering to be made via the rudder pedals. These push rods are curved to permit slight bending in the event of large opposing forces from two pilots being applied to the rudder pedals. In this event, a large proportion of the load is borne by the rudder cables themselves.

Two light springs are fitted to the rudder pedals to aid centering.

Pushing the right rudder pedal forward results in the rudder moving to the right; pushing the left pedal forward results in the rudder moving to the left.

Trim

An electric pitch trim system is controlled from a rocker switch in the dash. Pressing the top of the rocker switch lifts the trailing edge of the trim tab and results in a pitch down trim; pressing the bottom depresses the trim tab and results in a pitch up trim. The switch controls a small servo motor near the trailing edge of the fixed stabilizer. A short push rod runs from this servo motor to the trim tab horn. Raising the trim tab in flight results in a down deflection of the trailing edge of the elevator and a nose down pitch. A panel-mounted meter indicates trim position.

If the trim runs away to one extreme or fails in one position, no undue stick force is required to maintain control.

Brakes

The control stick carries a brake lever with an integrated master cylinder. Hydraulic lines carry pressure to a small disc brake on each of the main wheels. The brakes work together.

On systems fitted with the Beringer brake modification a pressure limiting device is incorporated in the system between the brake handle and the brake callipers.

General maintenance to ensure good brake performance

- The engine idle speed must not be higher than 1750 rpm. To avoid a continual fast taxi situation experiment lowering the idle speed to about 1600 rpm. This will remove the need to constantly apply the brakes when taxiing.
- If operating from a hard runway it is inevitable that the brakes will be worked much harder than if operating from a grass runway. When taxiing avoid constantly holding pressure on the brake lever, this accelerates brake pad wear. Apply the brakes periodically, say every 5 seconds instead.
- For the Beringer brake modification consult the Beringer Maintenance Manual appended to this Owner's Handbook.
- Jack up each main wheel and spin the wheel checking the brake disc runs centrally between the brake pads. If the brake disc runs biased over to one side then when the brakes are applied, contact performance with the two pads will be lost and the brakes become less efficient. To centralise the brake disc loosen the brake caliper bolts and insert shims between the caliper and the mounting bracket until the brake disc is centralised.
- The brake pads do not have a very thick lining even from new so do not be fooled into thinking a set of part worn pads are ready for replacement.
- Keeping the brake lever pressure quite high ensures good brake performance. The adjustment plunger on top of the brake fluid cylinder needs to be screwed down periodically to maintain the pressure in the system.
- As the brakes slowly wear and the adjustment plunger is screwed down to its lowest point it becomes necessary to top up the brake fluid level.

Electrical circuit diagrams are given at the end of this manual. Note that the MIPS electronic engine monitoring system is optional.

Battery

A small lightweight lead acid battery is installed beneath the seats for engine starting. It has a capacity of 5 amp hours and very high current capability. No maintenance is required, apart from keeping the contacts clean and dry. The battery is charged from the engine's in-built alternator, via a rectifier-regulator unit.

The engine ignition system is independent of the rest of the electrical system and does not require the battery to operate.

Fuses

Fuses are provided to protect wiring to all the electrical services with the exception of the starter motor. If a fuse blows, it is important to determine the cause of the failure before replacing the fuse. Under no circumstances replace the fuse with one of a higher rating.

Instruments

A variety of electrical instrument configurations is available, with an essential minimum as follows:

- Fuel gauge
- Tacho
- Cylinder Head Temperature gauge (CHT) *

*** Note: there may be a significant difference between the CHT reading and that of the coolant temperature, with the CHT gauge likely to read low, and to have a slower response. Although the CHT gauge may indicate an acceptable temperature, it must not be assumed that the coolant temperature lies within limits.**

Switches

A master switch provides isolation of the battery from the main bus. The master switch must be closed (on) before attempting to start the engine, and must remain on to ensure that the battery is charged properly.

Separate isolating switches are provided for the remaining services or groups of services. Where a radio is installed, it is wise to turn off the radio switch before starting to reduce the risk of high spurious voltages damaging the radio.

NOTE: - The ignition switches stop the engine by grounding the ignition circuit. The engine is started and runs with the switches open, and is stopped by closing the switches. The ignition switches are therefore mounted in the reverse sense to the other switches to enable the normal aviation switch sense to be maintained. ie. up for ON, down for OFF.

It is also important to note that disconnection of the ignition switch wires, by accident or during maintenance, renders the engine live. Great care must be exercised in this case to ensure that the engine cannot be started accidentally. Normally remove the spark plugs' caps.

10.5 Ballistic Recovery System

The ballistic recovery system consists of a parachute attached to the airframe designed to lower the entire aircraft and occupants to the ground.

The parachute is mounted towards the tail end of the fuselage, on top of the pair of bracing tubes inside the fuselage fairing. The parachute is fitted inside a fabric container, and it is pulled out of the aircraft by a small rocket motor attached close to the parachute container. The bridles from the parachute are attached to the airframe on the cross-tube aft of the seats, and to the main tube via the front strut forward of the cockpit.

Deployment is activated by pulling a handle located above the cockpit area between the pilots. When on the ground the handle is secured against accidental activation by a small padlock, the key for which should be attached to the aircraft master key.

SECTION 11 - INSPECTION AND MAINTENANCE

11.1 Daily Inspection / Pre-flight Inspection

1. Engine and cowling secure and undamaged.
2. Check coolant level correct.
3. Check oil level within limits.*
4. Propeller clean and undamaged¹, bolts secure.
5. Front gear; tyre pressure, tyre condition and tyre creep.
6. Left main gear; tyre pressure and condition.
7. Left side wing, structure and covering.
8. Left wing strut attachment secure.
9. Left aileron, control linkage and hinges secure.
10. Left flap, control linkage and hinges secure.
11. Left side of the fuselage, undamaged
12. Tail group secure and surfaces undamaged.
13. Elevator hinges and control linkage secure.
14. Trim tab and linkage secure.
15. Rudder hinges and control cables secure.
16. Repeat items 4 thro' 11 for right side.
17. Fuel filler cap secure.
18. Windscreen clear and undamaged.
19. ASI pitot unobstructed and fully extended.
20. Cockpit area inside and out, check controls full movement, free and correct sense.
21. Instruments serviceable.
22. Open fuel tank sump drain and check for contamination.
23. Check tank water drain for leaks.

**When checking the oil level it may be necessary to pump the oil back into the reservoir to obtain a correct reading and to avoid overfilling. This can be done by removing the oil filler cap and ensuring the master switch and magnetos are off and rotating the propeller ONLY in the operating direction until a gurgling sound is heard from the reservoir tank.*

¹ With composite propellers, minor damage to the external surface, such as a deep scratch which breaches the outside fabric, can result in significant loss of strength and a dangerous condition. For this reason it is important to inspect the blades carefully before flight. Look particularly for scratches along the chord of the blade which may have severed one or more yarns of fibre. When in doubt, seek expert advice.

- *Neuform propellers must be returned to Neuform in Germany for an inspection every 500 hours or 2 years whichever comes first. Please refer to your propeller operating manual.*

11.2 Periodic Maintenance and Inspection

Servicing, maintenance and repair work on this class of aircraft can be performed by the pilot. Certain work must be signed off in the Engine and Airframe Logbook by a PFA or BMAA Inspector. Definitions of Pilot Maintenance work is obtainable from the BMAA and PFA. Use only approved spare parts and never fit damaged parts.

All servicing, maintenance and repair work on the aircraft, including the engine, propeller and ballistic recovery system (if fitted), should be recorded in the Engine and Airframe Logbook.

Every 25 hours inspection

Engine: Check 25 hour inspection items in accordance with the ROTAX manual.

Fuel system

1. Check tank internally for cleanliness.
2. Check fuel filter for cleanliness.
3. Check all fuel lines for degradation.

Airframe

1. Check control stick for freedom without undue friction.
2. Check safety lock plates at the bearings at front and rear ends of control stick torsion tube.
3. Check that rod end bearings on elevator push rods suffer no bending at each extreme lateral position of stick (aileron limits).
4. Check all lock nuts for tightness.

Wing

1. Check internal bracing wires for adequate tension.
2. Check freedom of ailerons.
3. Check aileron and flap hinges for wear.
4. Check aileron and flap hinge bolts for tightness (cannot rotate)

Tail Empennage

1. Check rudder hinges for wear.
2. Check elevator hinges for wear.
3. Check rudder and elevator hinge bolts for tightness (cannot rotate)
4. Check rudder cables for wear at fairleads.

50-Hours Inspection

Engine:

Check inspection items in accordance with the ROTAX manual.

Additionally to the 25 hour schedule:

1. Check rudder and aileron cables for wear and damage.
2. Check brake pads, brake disks and brake function.
3. Lubricate the nose leg bearings with a grease gun at the upper and lower grease nipples.
4. Check rudder cable tension, 25 to 35 kgf.
5. Check aileron cable tension, 18 to 24 kgf
6. Change the fuel filter.
7. Check stub axles for cracks.
8. Check seat support tube cannot rotate.

100-Hour or Annual Inspection

Engine:

Perform 50 hours checks in accordance with ROTAX manual.

Additionally to the 50 hour schedule:

1. Clean, grease and check security of ball joints on steering rods at foot pedals and operating bar of front wheel.
2. Clean, grease and check security of rod end bearings at stick torsion tube.
3. Clean, grease and check freedom of throttle control; ensure that the cable cannot stick, even when closed slowly.
4. Clean, grease and check security of all ball and fork hinges at each aileron push rod end.
5. Check all hinges for excess play. Clean and grease all hinges and remove rudder to check clevis pins for excess wear.
6. Check all lock nuts for proper installation; check 2 threads showing.
7. Check central and internal wing-mounted aileron bellcranks for freedom and security. Clean and grease bellcrank ball connections, and, if necessary, bellcrank bearings.
8. Check cross bolt and connections of elevator motion reversal lever for security and wear.
9. Check bearing of reversing lever for wear and freedom. Clean and grease central bearing.
10. Clean, grease and check security of rod-end bearings of elevator push rods; tighten and Loctite locking nuts.
11. Remove exhaust and check for cracks especially around cockpit heater jacket.

Replace cockpit carbon monoxide detector in accordance with manufacturers instructions.

11.3 Jacking the Aircraft

Either of the main wheels can be brought clear of the ground by one person lifting the wing at the top of the wing struts. (Never apply any significant up load to the centre of the struts). The aircraft can then be chocked by placing a wooden block under the bottom part of the stub axle. This is also a suitable jacking point where a second person is not available to lift the wing.

The nose wheel is easily lifted by applying a load to the rear fuselage, just forward of the tail. Where one person only is available, place weights on the tail, suitably padded to prevent damage to the fabric, until the nose wheel becomes light. Place a piece of timber under the tail skid, then push the tail down on to it. Add further weights to the tail to stabilise the aircraft in this attitude.

11.3 Cleaning and Repair of the wing fabric

Cleaning

Clean the wing coverings with warm water and a mild detergent, such as washing up liquid, to remove oil. Never use solvents. All metal parts are anodized aluminum or stainless steel and need no special attention.

Dirt or mud on wing surfaces should be removed with clean water. Avoid the use of a pressure washer or hose pipe as this can introduce water into places it shouldn't go, (engine, fuel tank, pitot head, pilot's seat).

Repair

Repair even the smallest tears in the covering fabric.

Carefully clean the area around the tear, then attach a small patch with contact adhesive covering an area at least 15 mm larger than the damage all round. Alternatively apply a small patch of self-adhesive material. For larger areas of damage, consult the importers, Performance Aviation Ltd.

In the event of technical problems, contact Performance Aviation Ltd.

SECTION 12 - WING RIGGING AND DE-RIGGING, FLYING WITH DOORS REMOVED

12.1. Attaching the wings to the folding mechanism. (Optional).

The C-42 has an optional folding wing which minimises hangar space. For road transport however you must remove the wings completely. To attach the wings to the folding system:

Step 1. Fit the jockey wheel to the stern post, fit the triangular wooden support brackets to the bottom of the tailplane struts, with the aluminium strip uppermost.

Step 2. Remove the stop ring from the slide tube in the cockpit roof.

Step 3. Place a wing parallel to the fuselage with its tip supported on the tail by the wooden support bracket.

(With both wings folded back and supported by the tail, the aircraft will rock back to sit on its tail. With only one wing on the tail, the aircraft can be tipped forward to a stable attitude resting on its nose wheel. Be aware of these movements during rigging and derigging operations. Take care to protect the wing from damage by contact with the ground).

Step 4. Lift the wing root and slide the attachment block (roller) 2 inches (5cm) over the slide tube.

Step 5. Attach the stop cable on the leading edge to the quick link on the slide tube.

Step 6. Attach the stop ring to the end of the slide tube.

If both wings are in the folded back position the C42 can be easily moved by one person into a small hangar space.

12.2 Rigging the wings

If you are tall but weak, it may be easier to manipulate the wing during rigging by holding it at its tip. If you are short and strong, the better handling point is the top of the wing struts. If you are short and weak, fetch a friend. If you are short, weak and friendless, don't derig.

Before attempting rigging, take a look at the wing roots and the way in which the rigging mechanism works. Note that the fulcrum (the roller bracket) is located near the wing root, and also in line with the rear spar attachment point. The front spar attachment point however is located some way inboard. This means that lifting the wing tip will result in the front spar clearing its fitting before the rear one. This can be used to advantage during rigging.

Step 1. Ensure that the spar channels in the cockpit roof are aligned with the top surface of the cockpit roof frame. Lock the controls, place the flap lever in the fully up position and ensure the brake is on.

Step 2. Bring the left wing strut into its correct position on the left wing and attach the auxiliary (jury) struts on the front and rear wing struts to the leading and trailing edge fittings.

Step 3. If this is the first side to be rigged and the second wing half is still resting on the tail, lift the wing at its tip with one hand. With the other hand, steadily lift the tail so that the aircraft rests on its nosewheel.

Step 4. Carry the wing into its 90° position relative to the fuselage, taking care not to damage the door and fuselage with the front spar.

Step 5. Turn the wing into a horizontal position and push it gently towards the fuselage.

Step 6. Lifting the tip, slowly insert the wing roots into position in their channels, leading edge first.

It may be necessary to gently rock and twist the wing to engage the spar hooks on to their pins.

Step 7. Ensure that front and rear wing spars are properly engaged in their channels. Then insert the lower end of the wing struts into the open box-section end at the top of the shock absorbers.

Step 8. Attach front wing bolt and safety pin, using the tool provided.

Step 9. Attach rear wing bolt and safety pin.

Step 10. Attach the strut bolt through the box-section end and lower steel block of the wing struts ends. Install the safety pin.

Step 11. Check that all three bolts have their safety pins installed.

Step 12. As a final check, lift the wing at the wing tip to ensure proper attachment of the wing strut block to the box-section end.

Step 13. Connect the pitot tube to its fitting situated to the left of the pilot's headrest. Pull out the pitot tube forwards to its full extent.

Step 14. Repeat steps 1 through 12 for the other wing. Now you may remove the control lock.

Step 15. Attach right and left aileron push rods to the central bellcrank connection. Carefully ensure that the slide mechanisms of the special link connectors are properly engaged (closed and locked).

Step 16. On the flap drive tube, take the split sleeve fitted around the sprung taper pins (and through which they protrude), spread it a little, then rotate it over the pins. Using this sleeve as an aid, squeeze it, thus compressing the pins. Then move the sleeve so that the drive fitting moves freely on its tube.

Step 17. Align the flap root tube and its drive fitting on the fuselage. Slide the flap drive fitting over the junction so that its cutaways engage snugly in the roots of the flap frame tubes and the sprung pins are fully out. Rotate the split sleeve so that its holes align with the tips of the pins again, permitting the pins to spring out fully. Left and right landing flaps must be securely locked and it may be necessary to wiggle the fitting a little to ensure proper engagement, particularly when the aircraft is new.

Step 18. Position and fasten the wing centre section (cockpit roof).

12.3 Folding the wings to hangar the aircraft:

Step 1. Apply the brake. Fit the dolly wheel to the stern post.

Step 2. Push in the pitot tube on the left wing.

Step 3. Remove wing centre section.

Step 4. Disconnect the pitot tube from its fitting above the pilot's seat back.

Step 5. Place a triangular wooden support bracket (supplied) on to the lower part of the tailplane strut at each side, with the aluminium strip uppermost.

Step 6. Set the flap control in its fully up position.

Step 7. Disconnect the landing flaps by first spreading and rotating the aluminium split sleeve on the flap drive fitting. Then push in the spring loaded pins by squeezing the split sleeve.

Step 8. With the trailing edge of the flap resting on your shoulder, squeeze the split sleeve with one hand and, holding the knurled ring in the other, push the assembly inboard until it clears the drive tube junction. Lower the flap gently.

Step 9. Unlock the aileron push rods from central bellcrank connections.

Step 10. Remove the keep rings from the front and rear spar pins and the lower strut pin, at each side, (total 6 rings).

Step 11. Unlock the strut block from lower box section end by removing the strut pin, using the special tool provided.

Step 12. Unlock the rear wing spar by removing its pin.

Step 13. Unlock front wing spar by removing its pin, hold down the top of the screen to prevent damage.

Step 14. Close the door.

Step 15. Lift the left wing at its wing tip, or strut tops, so that wing strut block leaves the square box-section end. By lifting the wing high you will first disconnect the front spar hook from its pin and frequently the rear spar at the same time. If the rear spar does not disengage, gently rock the wing from side to side, pulling gently and twisting it until it does.

Step 16. Pull out the wing until it stops on the stop wire. Ensure that the stop wire runs over the TOP of the aileron operating push tube before folding back the wing.

Step 17. Draw back the wing away from the fuselage until the movement is stopped by the stop ring on the slide tube.

Step 18. Rotate the wing into a vertical position - underside of the wing to the front; trailing edge down.

Always hold the wing tip higher than the root to prevent damage to the door and fuselage with the spars' ends.

Step 19. Carry the wing tip back into a position parallel to the fuselage. If the wing has been supported at the strut tops, it will be necessary to set it down and pick it up again by its tip for the next step. During this operation, ensure that the wing cannot tip forwards by walking your hands along the leading edge to the tip.

Note that the aircraft will tip back upon folding the second wing.

Step 20. Separate the Velcro for 2 or 3 inches (50 to 75 mm) along the aileron root at a point where the support bracket meets it.

Step 21. Place the wing trailing edge onto the retainer bracket on the tail.

Step 22. Remove the pin from the top of each jury strut.

Step 23. Rotate the jury struts carefully so that they lie parallel and next to each other.

Step 24. Undo the inboard zip on the wing's lower surface, adjacent to the jury struts.

Step 25. Fold in the main struts to lie flat against the lower wing surface. Secure the strut bottom with the bungee attached to the wing root.

Step 26. Fold back the right wing according to steps 1 to 25.

12.4 Flying Without Doors – Aerosport MOD C42/019

Both doors must be removed. It is not permissible to remove just one door.

Ensure when flying with the doors removed that there are no loose items, take special care to check under the seats. Items stowed under the seat must be in a soft container that is unable to slide forward or interfere with the throttle (A suitable container is available from the manufacturer). Also wear suitable clothing that will not flap or flail around in the cockpit. It is recommended that maps are placed in a suitable map holder that can be anchored to the pilot or passenger.

Follow the instructions for removing and replacing the doors carefully.

- Open door and remove safety clip from gas strut and safety ring from rear clevis pin but do not unclip gas strut or remove clevis pin at this stage.
- Place a piece of tape over the hinge bolt to prevent it turning in or out.
- Carefully support the door and unclip the door strut ball joint then remove the clevis pin.
- Carefully slide the door off the front locating spigot & store the door somewhere safe.
- Re-fitting is simply a reversal making certain to re-fit safety rings & clips.
- Have your work checked by your local PFA or BMAA inspector.

SECTION 13 - SETTING (RIGGING) AND MISCELLANEOUS DATA

13.1 Incident angle of wing with respect to main fuselage tube: 8°

Note: The incident angle is defined as the angle between a line parallel to the fuselage tube and a line joining the undersides of the leading and trailing edge tubes at their roots.

13.2 Angle of stabilizer with respect to the main fuselage tube: 7°

Note: The stabilizer angle is defined as the angle between a line parallel to the fuselage tube and a line joining the undersides of the leading edge and trailing edge of the stabilizer.

Angle difference between wing and stabilizer: 1°

13.3 Control Surface Deflections

Aileron Up 20 ±2° or 85 mm, ±9 mm measured 250 mm from the hinge axis.

Down 14° ±2° or 60 mm, ±9 mm measured 250 mm from the hinge axis.

Area 0,58 m² per side.

Elevator Up 30° ±3° or 205 mm ± 21 mm measured 410 mm from the hinge axis.

Down 20° ±3°. Or 140 mm ± 21 mm measured 410mm from the hinge axis.

Area 0.82 m² total

Rudder L/R 32° ±3° or 217 mm ± 21 mm measured 410mm from the hinge axis.

Area 0.44 m²

Fin Area 0.61 m²

Stabilizer Area 1,42 m²total

Flaps - 4.5° -15° - 42°
Relative to the fuselage tube.

Area 0.46 m² per side.

Elevator Trim Tab Up 1 to 5°
Down 25°±3° (relative to elevator)

13.4 Air pressure for tyres and shock absorber:

Main wheels 1.8 - 2.5 bar 26 to 36 psi.

Front wheel 1.5 - 1.8 bar 22 to 26 psi.

Shock absorbers 29 - 33 bar 425 to 486 psi

A special pressure pump, available from Performance Aviation Ltd, is used for setting the shock absorber pressures.

Tachometer 912

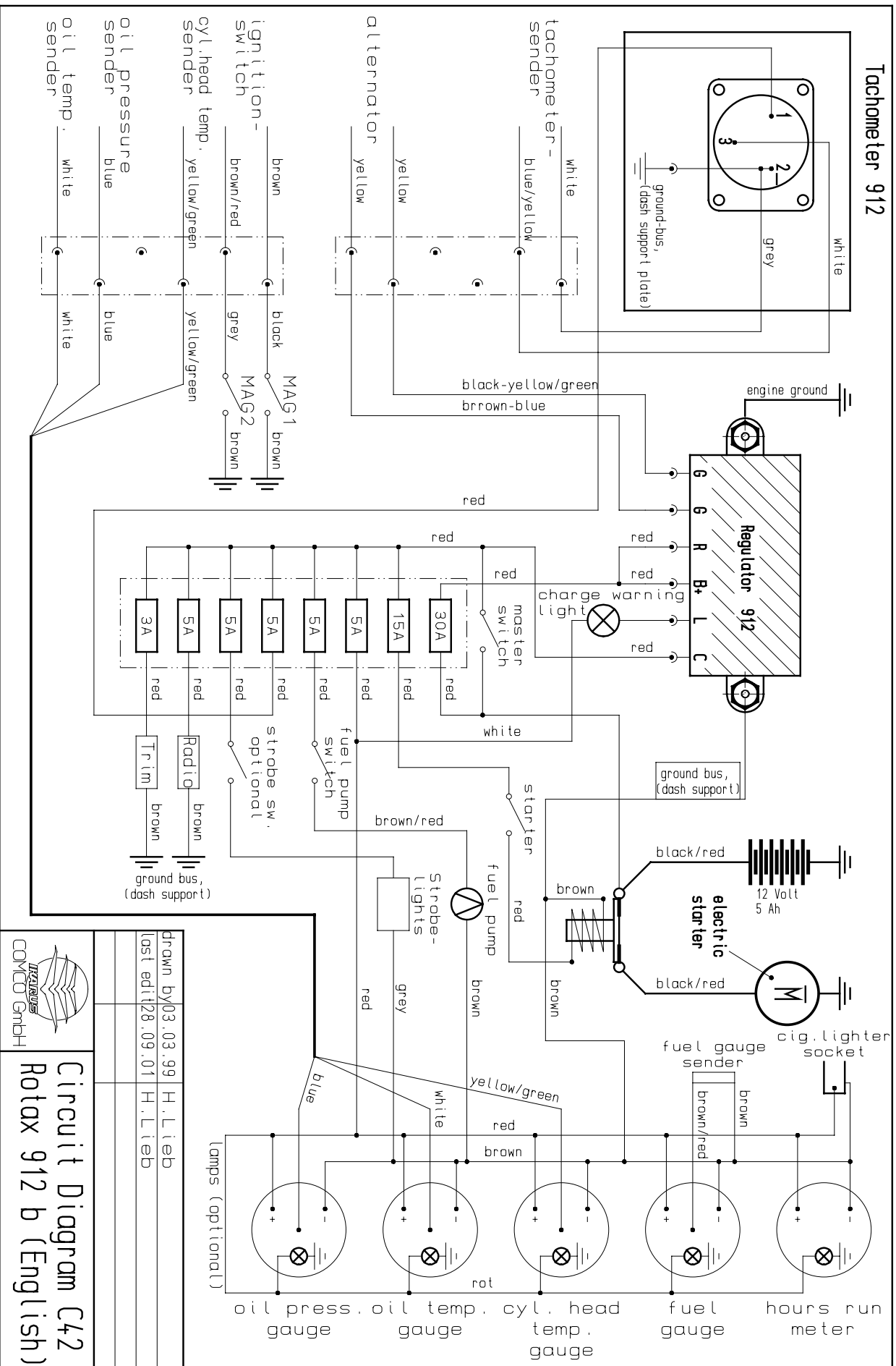

Circuit Diagram – Standard Installation.

Rotax 912 b (English)
 Circuit Diagram
 H. L. Lieb
 H. L. Lieb
 03.03.99
 28.09.01

Circuit Diagram – Trim Tab

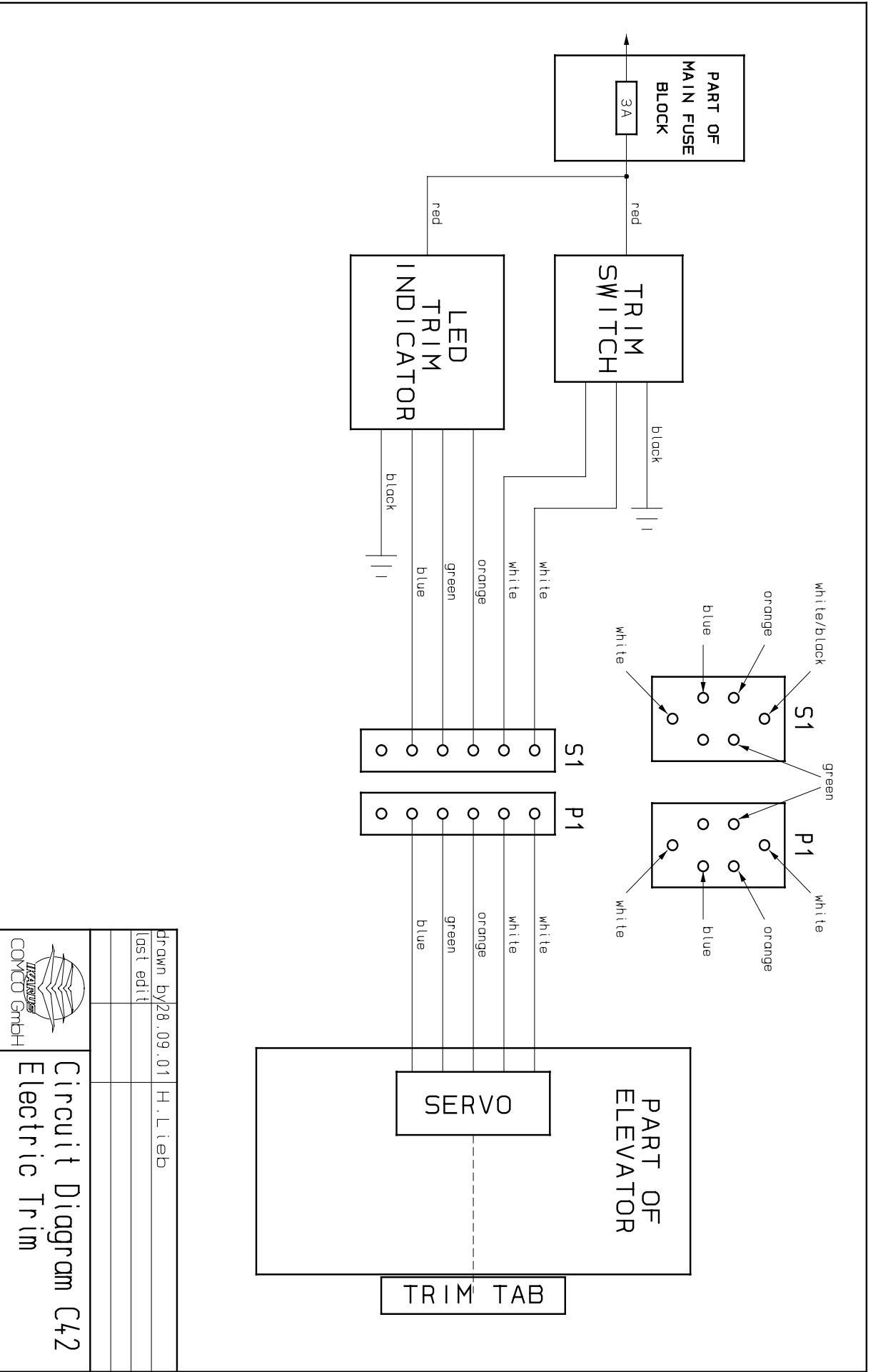

drawn by/28.09.01	H. L. ieb
last edit/	
	
Circuit Diagram C42 Electric Trim	

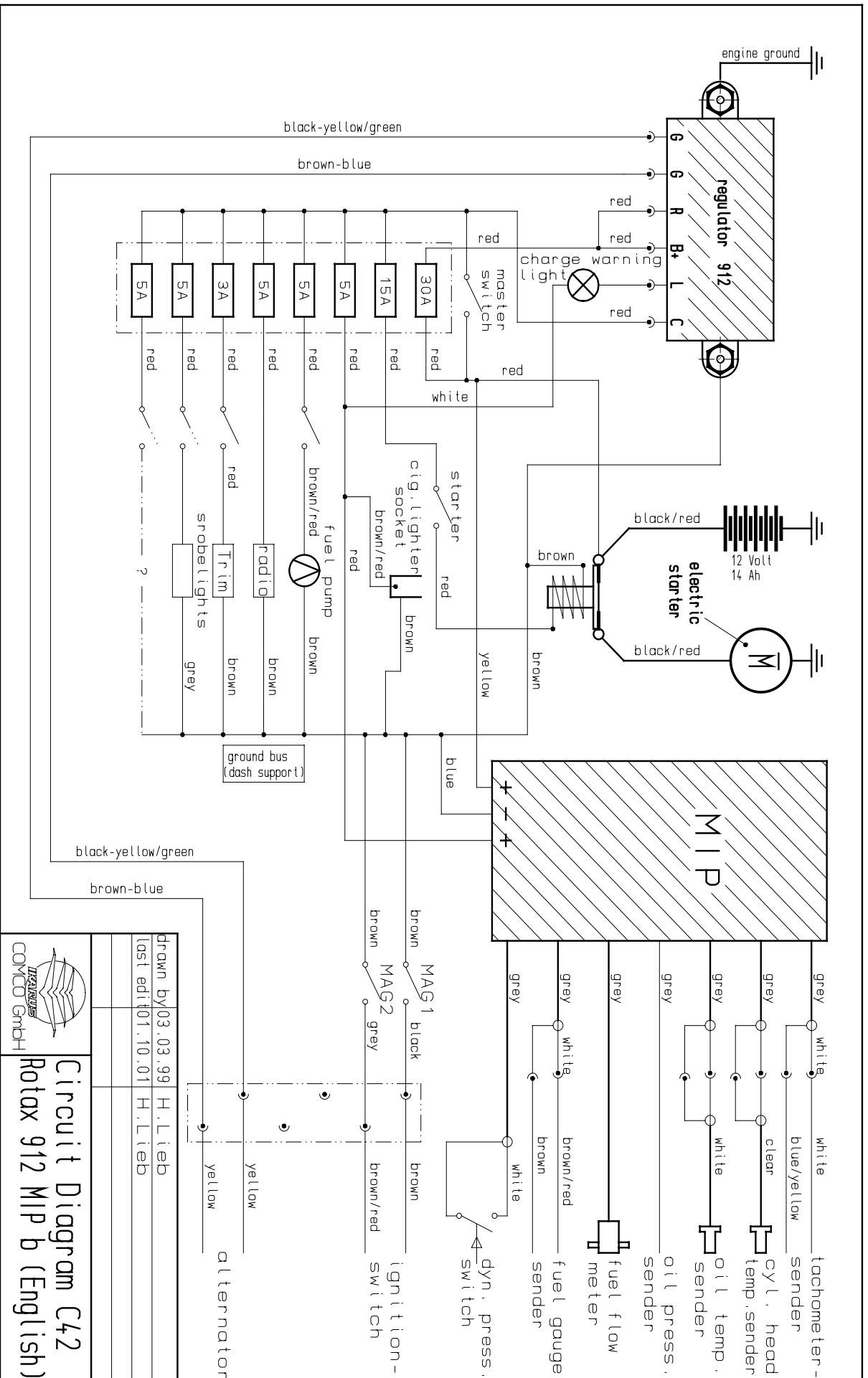

Circuit Diagram – MIP installation.

 COMCO GmbH	Circuit Diagram C42 Rotax 912 MIP b (English)	
	drawn by 03.03.99 H.L. Lieb last edit 10.10.01 H.L. Lieb	yellow yellow alternator