

ATR833-LCD

VHF Communication Transceiver



P/N 833-(3xx)-(3xx)

Operation and Installation

(Dokument-Nr. 01.1404.010.71e)

Change History

Revision	Date	Description of Change
1.00	22.06.2012	FAV – First Release new LCD-Generation (2-Knob-HMI)- Extended control menu Sw V7.0
1.01	10.06.2013	Information about dual-watch-operation
2.00	22.01.2014	Change of company name to f.u.n.k.e. AVIONICS GmbH Information about antenna cable chapter4.8

List of the Service Bulletins (SB)

Services bulletins are to be inserted in the manual and to be put down in this table.

SB Number	Rev. No.	Issue Date	Entry Date	Name

Survey of Variants

Part Number	Description
P/N 833-(300)-(300)	New LCD-Generation – 2-knob-HMI
P/N 833-(301)-(310)	New housing variant (weight reduction) and new SW V7.2

CONTENTS

1	GENERAL	5
1.1	SYMBOLS.....	5
1.2	ABBREVIATIONS.....	5
1.3	CUSTOMER SUPPORT.....	6
1.4	FEATURES.....	6
2	OPERATION	7
2.1	CONTROLS.....	7
2.2	ON/OFF.....	9
2.3	DISPLAY.....	9
2.4	BASIC SETTINGS.....	11
2.4.1	VOL - Volume.....	12
2.4.2	SQL - Squelch.....	12
2.4.3	DIM – Backlight ON/OFF.....	13
2.4.4	VOX – Voice Detection (Speech Threshold for Voice Activated Intercom).....	13
2.4.5	DWM – Dual Watch Volume Reduction.....	14
2.4.6	INT - Intercom-Volume.....	14
2.4.7	EXT - Volume of the External Audio Input.....	15
2.5	FREQUENCY SETTING.....	16
2.5.1	Automatic 8.33 / 25 kHz Channel Width Selection.....	16
2.5.2	Manual Frequency Input.....	16
2.5.3	Recall a Frequency from the User Memory.....	17
2.5.4	Recall a Frequency from the List of the 10 Last Used.....	18
2.5.5	Store a Frequency into the User Memory.....	18
2.6	DUAL WATCH OPERATION.....	20
2.7	TRANSMISSION.....	22
2.8	RECEPTION.....	22
3	CONFIGURATION	23
3.1	SPC – CHANNEL SPACING.....	23
3.2	CON - CONTRAST.....	24
3.3	DPY – ENERGY SAVING MODE (AUT. DISPLAY DARKENING).....	24
3.4	PTT-BUTTON SELECTION.....	25
3.5	EXT – EXTERNAL AUDIO INPUT’S BEHAVIOR.....	26
3.6	MICROPHONE INPUT SENSITIVITY.....	27
3.6.1	MLS – Standard Microphone Pilot/Left.....	27
3.6.2	MLD – Dynamic Microphone Pilot/Left.....	27
3.6.3	MRS – Standard Microphone Copilot/Right.....	27
3.6.4	MRD – Dynamic Microphone Copilot/Right.....	27
3.7	TST – TEST MODE.....	29
3.8	MASTER RESET.....	29
4	INSTALLATION	30
4.1	ADVICES AND TIPS.....	30
4.2	TELECOMMUNICATION DATA.....	30
4.3	SCOPE OF DELIVERY.....	30
4.4	UNPACKING AND INSPECTING THE EQUIPMENT.....	31
4.5	MOUNTING.....	31
4.6	EQUIPMENT CONNECTIONS.....	32
4.6.1	Microphone-Connection.....	32
4.6.2	Headset-Connection.....	32
4.6.3	Audio-Input.....	33
4.6.4	Remote Control Panel.....	33
4.7	WIRING.....	34

Operation and Installation

4.7.1	Conductor Cross Section	34
4.7.2	Connector – Pin Allocation.....	34
4.7.3	Wiring with Cable Harness BSKS833S/BSKS833D	36
4.8	ANTENNA	38
4.8.1	Antenna Selection	38
4.8.2	Antenna Cable.....	38
4.8.3	Installation Recommendation.....	38
4.9	MICROPHONE / INTERCOM SETTINGS	39
4.10	POST-INSTALLATION CHECK.....	40
4.11	DRAWINGS	40
4.11.1	Dimensions.....	40
4.11.2	Mounting Advices.....	41
5	APPENDIX	42
5.1	FREQUENCY/CHANNEL-PLAN	42
5.2	TECHNICAL DATA.....	43
5.3	ENVIRONMENTAL CONDITIONS.....	45

1 GENERAL

This manual contains information about the physical, mechanical and electrical characteristics, as well as information about installation and operation of the aeronautical VHF voice radio ATR833.

1.1 Symbols

	Advices whose non-observance can cause radiation damage to the human body or ignition of combustible materials.
---	---

	Advices whose non-observance can cause damage to the device or other parts of the equipment.
---	--

	Information
---	-------------

1.2 Abbreviations

Abb.	Name/subject	Definition
DIM	Dimming	Display Brightness
EXT	External audio input	Volume of external audio signal
INT	Intercom	Volume of board-internal intercom
MIC	Microphone	
PTT	Push-To-Talk	Key to activate radio transmission
SEL	Selection	
SQ	Squelch	Noise suppression radio reception
VOL	Volume	Volume of radio reception
VOX	Voice activation	Volume threshold for voice-activated intercom

1.3 Customer Support

In order to facilitate a rapid return of shipments in case of repairs, please follow the instructions of the input guide "Reshipment RMA" provided at the Service-Area within the f.u.n.k.e. AVIONICS GmbH web portal www.funkeavionics.de.



Any suggestions for improvement of our manuals are welcome. Contact: service@funkeavionics.de.



Information on software updates is available at f.u.n.k.e. AVIONICS GmbH.

1.4 Features

- VHF communication transceiver with 6W output power in 57 mm format
- Frequency range 118,000 to 136,975 MHz
- Automatic selection of 8,33/25 kHz channel spacing
- 4 microphone inputs (2 x standard, 2 x dynamic)
- Voice controlled intercom for up to 4 microphones, can be deactivated for use with external intercom
- Dual-watch technology, simultaneous monitoring of two frequencies
- Auxiliary audio input
- Memory for up to 100 user-definable named frequencies
- User-defined frequency list exportable/importable to/from PC (via RS232) - PC software available at www.funkeavionics.de
- Easy recall of the 10 last used frequencies
- LCD display for best readability under all conditions
- Configurable energy saving



To avoid unintentional permanent transmission, the transmitter automatically stops transmission after two Minutes of uninterrupted operation.

2 OPERATION

2.1 Controls

Use together to adjust volume, squelch or other setting

SET

Short press:

Choose item to be adjusted with **VOL / SEL**

Very long press:

Access configuration menu

VOL/SEL

Rotary knob

Adjust value or select item given within the display's lower left corner:

Chosen with **SET**:
adjust VOLUME, squelch, etc.

Chosen with **MEM**:
SELECT item from list of frequencies

ON/OFF

(Radio must be on)

DW

Activate / Deactivate dual watch reception of standby frequency

CHANGE

Swap active and standby frequency

CURSOR

Short press:

Set underline to select which value to be changed with **FREQ**

Long press:

In MEM only: add name to memory item

FREQ

Rotary knob

Change underlined value

MEM

Short press:

Access user frequency memory / list of last used frequencies





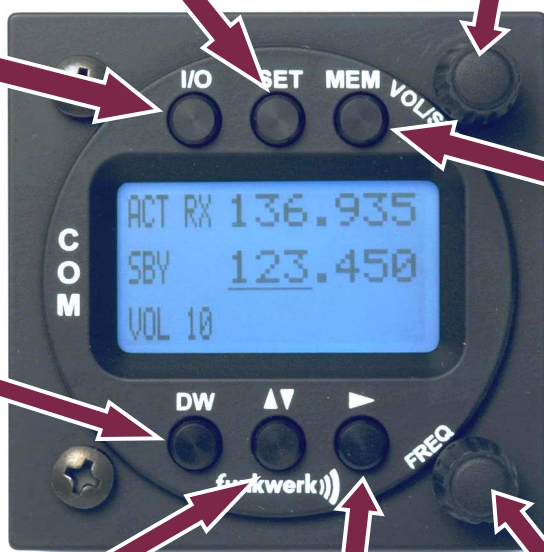



Long press:

In MEM only: store frequency/name



Use together to change standby frequency

Operation and Installation

	ON/OFF	Switch On press button for approx. 0.5 s Switch Off press button for approx. 2 s
	DUAL WATCH	Activates/deactivates the mode for mutual reception of standby frequency (display shows DW instead of SBY)
	SET	<ol style="list-style-type: none"> Choose item VOL, SQ, VOX, DIM etc. (each adjusted by VOL / SEL) →press button shortly Shortcut to volume setting →press button for at least 1.5 seconds Enter configuration menu →press button for at least 5 seconds
	CURSOR	<ol style="list-style-type: none"> Move underline within standby frequency, to be adjusted by FREQ →press button shortly Add name to frequency within memory →press button for at least 1.5 seconds
	CHANGE	Swap active and standby frequency
	MEM	<ol style="list-style-type: none"> Access user defined frequency list (MEM list). → press button shortly once Access list of 10 last used frequencies (LST list) → press button shortly twice Store active frequency to selected memory (only for MEM list) → press button for at least 1.5 seconds
 VOL / SEL	VOL / SEL Rotary Knob	<ol style="list-style-type: none"> Adjust volume or other item selected by SET (VOL, SQ, VOX, DIM etc.) Select frequency from user memory or list of last used frequencies
 FREQ	FREQ Rotary Knob	Change the underlined value (i.e. adjust standby frequency, or input character when entering name)

Operation and Installation

2.2 ON/OFF

Turn the device on with **I/O**

ON: **I/O** press button for 0.5 s

OFF: **I/O** press button for 2 s

After turning-on the display shows the software version as follows:

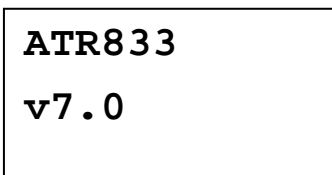

(Example)

Device Name
ATR833
Software-Version
e.g. v7.0

The Start Screen indicates device type and software version. After that screen the device changes into normal operation (direct input mode).

The radio starts with the same frequencies and settings from before being switched off.

2.3 Display

Use of active frequency:

TX = transmitting

RX = receiving

Te = timeout (solve and push PTT to re-enable transmissions)

Cursor marking:

Set position with **▶**, adjust value with **FREQ**

Fixed label for active frequency

Label for standby frequency:

DW = dual watch active
SBY = no dual watch

Item chosen by **SET**, or when accessing frequency list: Adjust value or select number with **VOL / SEL**

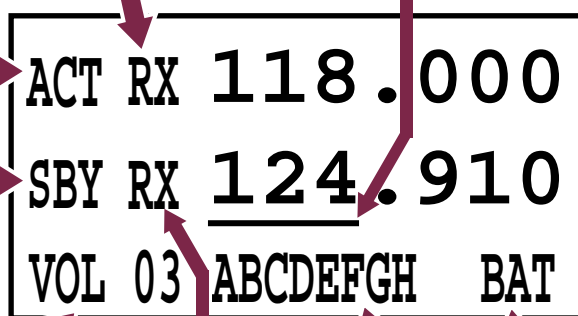

Active frequency

Standby frequency

Use of standby frequency: RX = receiving in dual watch mode

Low Battery warning

User-defined name, when selecting frequency from user memory

Operation and Installation

Display	Meaning	Remark
ACT	Fixed label for active frequency	
SBY	Label for standby frequency, when no dual watch activated	Dual watch mode allows intermittent monitoring of standby frequency activity
DW	Label for standby frequency, when dual watch mode activated	Dual watch mode allows intermittent monitoring of standby frequency activity
118.000	Active Frequency	Frequency used for transmissions and receptions
124.910	Standby frequency	May be monitored in dual watch mode
RX	Receiving on this frequency	Usually on active frequency; can also happen on standby frequency when dual watch activated
TX	Transmitting on active frequency	PTT pressed
Te	Transmission ended automatically after 2 minutes continuous transmission	Press PTT shortly to re-enable transmissions
VOL 03	Volume level for receiving	
SQL 03	Squelch level	Radio signal strength threshold required for reception; suppresses noise and weak/distant transmitter
DIM ON	Display brightness	Turns the backlight on or off
VOX 05	Vox level	Speech level that activates the intercom
DWM -2	Dual watch mute	Reduction in volume for dual-watch-reception on standby frequency
INT 04	Intercom volume	

Operation and Installation

Display	Meaning	Remark
EXT 02	Volume of external audio-signals	Set to 00, if no external device attached, to prevent noise pickup
MEM 00	Item from user memory	Substitutes standby frequency; can have name, if provided by user. Active frequency can be stored into this entry with long press on MEM
LST 00	Item from list of last used frequencies	Substitutes standby frequency
ABCDEFGH	User-provided name for frequency within user memory	Displayed while selecting from user memory, when the user has provided a name for this specific memory entry
BAT	Very low supply voltage	Transmission only with reduced power possible (decreased radio range!)
F1 ... F7	Internal failure	Device must be sent back to the manufacturer

2.4 Basic Settings

To choose between the following settings, use the **SET** button:

0. VOL Volume (chosen by default)
1. SQL Squelch
2. DIM Backlight ON/OFF
3. VOX Speech level required to activate the intercom
4. DWM Dual watch mute
5. INT Intercom volume
6. EXT Volume of external audio signals
- back to Volume

The return to the default display (VOL) is carried out by a long press of **SET** or happens automatically after 12 seconds of inactivity)

The chosen setting can be adjusted by the **VOL / SEL** rotary knob.

Operation and Installation

2.4.1 VOL - Volume

Can be reached by a long press of the **SET** button, but is also automatically chosen by the radio after 12 seconds of user inactivity.

Adjusts the volume of received radio signals by turning the **VOL / SEL** knob. The higher the value, the louder the reception of radio signals.

ACT	1 2 3 . 4 5 0
SBY	<u>1 1 8</u> . 9 1 0
VOL	0 3

↙ Range: 01 – 16



The VOL setting controls the volume of received radio signals only, not the volume of the intercom or the external audio input – these are set separately with INT and EXT .

2.4.2 SQL - Squelch

By shortly pressing the **SET** key once, with the help of the **VOL / SEL** rotary knob the squelch level can be adjusted. (Note: This is not related in any way to the intercom functionality.)

This is a threshold that has to be exceeded by radio signal levels from other transmitters, in order to activate the reception circuitry. The higher the number, the stronger the radio signals have to be in order to be received.

ACT	1 2 3 . 4 5 0
SBY	<u>1 1 8</u> . 9 1 0
SQL	0 7

↙ Range: 01 - 10

The setting for the squelch depends on different factors. For motor aircrafts an initial higher setting is typically appropriate, gliders may use a lower value. A lower number means higher input sensitivity. This allows reception of weaker signals (radio stations at higher distance), but can also result in pickup of own-aircraft radio interference sources (engine, strobe lights).



The default Squelch setting is 05. At higher values, weak signals could be suppressed.

2.4.3 DIM – Backlight ON/OFF

By shortly pressing the **SET** key twice, with help from the **VOL / SEL** rotary knob the backlight of the display can be switched on and off.

ACT	1 2 3 . 4 5 0
SBY	<u>1 1 8</u> . 9 1 0
DIM ON	

 Range: ON – OFF

2.4.4 VOX – Voice Detection (Speech Threshold for Voice Activated Intercom)

By shortly pressing the **SET** key three times, with the help of the **VOL / SEL** rotary knob, the threshold volume VOX for intercom voice detection can be adjusted. (Note: This is not related in any way to radio reception or squelch.)

VOX defines the crew's speech volume that is required to activate the intercom functionality. The higher the value, the louder you need to speak in order to activate the intercom.

Exception: VOX 01 corresponds to “always on”

The internal filter circuitry has the ability to distinguish between engine noise and speech.

ACT	1 2 3 . 4 5 0
SBY	<u>1 1 8</u> . 9 1 0
VOX 05	

 Range: 01 – 10

In case of very noisy backgrounds or use of uncompensated microphones, the automatic VOX functionality may not work satisfyingly. In these cases, it is possible to deactivate the VOX automatism with VOX 01, and to use an external intercom-switch.

2.4.5 DWM – Dual Watch Volume Reduction

By shortly pressing the **SET** key four times, with help from the **VOL / SEL** rotary knob the lowering of the volume level (“mute”) for receptions on the standby frequency (when having dual watch active) can be controlled. This allows acoustic distinction between both frequencies.

For further information about the dual watch mode see 2.6.

ACT	1 2 3 . 4 5 0
SBY	<u>1 1 8</u> . 9 1 0
DWM	-2



Range: -8 – 00

-8 is highest muting (dual watch reception at much lower volume)

00 is no muting (dual watch reception at same volume)

2.4.6 INT - Intercom-Volume

By shortly pressing the **SET** key five times, with help from the **VOL / SEL** rotary knob the intercom volume level can be controlled.

The intercom functionality is the on-board crew-internal communication for multiple-seated powered aircraft.

The intercom can be activated

- automatically whenever someone speaks into a microphone (i.e. voice activated intercom = VOX, see 2.4.4).
- manually by use of an external intercom switch.

The higher the value, the higher the intercom volume.

ACT	1 2 3 . 4 5 0
SBY	<u>1 1 8</u> . 9 1 0
INT	03



Range: 01 – 10



If the intercom is deactivated by cabling, the intercom volume cannot be adjusted. The radio indicates this by displaying INT --

Operation and Installation
2.4.7 EXT - Volume of the External Audio Input

By shortly pressing the **SET** key six times, with help from the **VOL / SEL** rotary knob, the volume from the connected external audio signals (Warning tones, music, etc...) can be set.

The higher the value, the higher the volume of the external audio signal.

A value of 00 deactivates the external audio input.

ACT	1 2 3 . 4 5 0
SBY	<u>1 1 8</u> . 9 1 0
EXT	0 3

 Range: 00 - 10



When no other device is connected to the external audio input, the input should be muted by selecting 00, in order to prevent noise by pickup of on-board interferences.



The priority of the external audio input in comparison to radio receptions can be configured, see 3.5.

2.5 Frequency Setting

Frequency setting is always done by the two steps of

1. entering a new standby frequency to the desired value, and then
2. interchanging the new standby frequency and the previous active frequency by using .

Entering a new standby frequency can be done by

- a) manual input,
- b) recall of previously stored frequencies from the user memory, or
- c) recall from the list of the last 10 used frequencies.

2.5.1 Automatic 8.33 / 25 kHz Channel Width Selection

Whether a frequency is used with channel width 8.33 kHz or 25 kHz, is automatically determined by the value of the frequency entered, and requires no additional user activity.

The numbering scheme that is used for distinction of the two channel widths is internationally standardised by the ICAO, and consistently used in official documents (like e.g. VFR navigation charts) as well as in the voice phraseology used by ATC radio communication.

Channels used with 25 kHz width are entered in multiples of 25kHz: 123.500, 123.525, 123.550, 123.575, 123.600 etc. These are compatible with the old 25kHz-only radios. To use the same frequencies with 8.33kHz width, the frequency values entered are increased by 5kHz: 123.505, 123.530, 123.555, 123.580, 123.605 etc.

For more detailed information please refer to chapter 5.1 – but as said above, for correct channel width selection this knowledge is not required.

2.5.2 Manual Frequency Input

The standby frequency is input by

- selecting with the  button which part of the frequency to change, and
- changing the selected part with the **FREQ** rotary knob.

The selected part of the frequency is marked with the underline.

 interchanges the newly set standby frequency and the former active frequency.



In order to speed up the entering of new frequencies, it is possible to configure the radio to allow entering of those frequencies only that are used with 25 kHz channel width.

Please refer to chapter 3.1 for information on this configuration.

However, when choosing this option, please keep in mind to re-enable 8.33 kHz channel selection before flying into areas where 8.33 kHz channels are used.

When having the channel selection configured for 8.33 kHz steps (see 3.1), the frequency is input in three steps:

123.450 → 123.450 → 123.450

When having the channel selection configured for allowing 25 kHz channels only (see 3.1), the frequency is input in two steps:

123.450 ↔ 123.450

2.5.3 Recall a Frequency from the User Memory

To access the user memory frequency list, press **MEM** once, and select one of the 100 memory entries with the **VOL / SEL** turn knob.

The selected memory entry substitutes the former standby frequency.

In the lower row of the display, the number of the memory entry selected is indicated by [MEM xx] (with xx = 00 ... 99); if a name has been provided by the user for this memory entry, it is displayed next to the memory entry number.

ACT	123.450
SBY	<u>121</u>.270
MEM 17	HAMBURG

↓
Entry number (Range: 00 – 99)

▲▼ interchanges the newly set standby frequency and the former active frequency, and leaves the memory list menu.

If no input is done for 12 Seconds, the device returns to the standard view, too.

2.5.4 Recall a Frequency from the List of the 10 Last Used

The radio automatically keeps track of the last 10 used active frequencies. To access this list, press **MEM** twice, and select one of the 10 list entries with the **VOL/SEL** turn knob. The selected memory entry substitutes the former standby frequency.

The number of the selected list entry is given in the display's lower row.

ACT	123.450
SBY	<u>118.700</u>
LST	01

↓
Entry number (Range: 00 – 10)



List entry „00“ contains the last standby frequency from the MEM menu.

Key **▲▼** interchanges the newly set standby frequency and the former active frequency, and leaves the last used list menu.

If no input is done for 12 Seconds, the device returns to the standard view.

2.5.5 Store a Frequency into the User Memory

The active frequency can be stored into any entry of the user memory.

This is achieved by a long press on **MEM** when having the user memory entry to be overwritten selected.

The following example stores the frequency 124.350 MHz of KONSTANZ into the user memory entry 07:

Operation and Installation

Step	• Display (Example)						
1. Have frequency to be stored set <u>as active frequency</u>	<table border="1"> <tr><td>ACT</td><td>1 2 4 . 3 5 0</td></tr> <tr><td>SBY</td><td><u>1 3 5</u> . 7 0 0</td></tr> <tr><td>VOL</td><td>0 3</td></tr> </table>	ACT	1 2 4 . 3 5 0	SBY	<u>1 3 5</u> . 7 0 0	VOL	0 3
ACT	1 2 4 . 3 5 0						
SBY	<u>1 3 5</u> . 7 0 0						
VOL	0 3						
2. <u>Enter memory list:</u> Press MEM once shortly in order to access the user memory. (This overwrites the former standby frequency.)	<table border="1"> <tr><td>ACT</td><td>1 2 4 . 3 5 0</td></tr> <tr><td>SBY</td><td><u>1 2 2</u> . 0 0 0</td></tr> <tr><td>MEM 00</td><td>KEMPTEN</td></tr> </table>	ACT	1 2 4 . 3 5 0	SBY	<u>1 2 2</u> . 0 0 0	MEM 00	KEMPTEN
ACT	1 2 4 . 3 5 0						
SBY	<u>1 2 2</u> . 0 0 0						
MEM 00	KEMPTEN						
3. <u>Select the memory position to be used</u> with VOL / SEL	<table border="1"> <tr><td>ACT</td><td>1 2 4 . 3 5 0</td></tr> <tr><td>SBY</td><td><u>1 2 1</u> . 2 7 0</td></tr> <tr><td>MEM 07</td><td>HAMBURG</td></tr> </table>	ACT	1 2 4 . 3 5 0	SBY	<u>1 2 1</u> . 2 7 0	MEM 07	HAMBURG
ACT	1 2 4 . 3 5 0						
SBY	<u>1 2 1</u> . 2 7 0						
MEM 07	HAMBURG						
4. <u>Overwrite the selected memory entry</u> with a long press of MEM .	<table border="1"> <tr><td>ACT</td><td>1 2 4 . 3 5 0</td></tr> <tr><td>SBY</td><td><u>1 2 4</u> . 3 5 0</td></tr> <tr><td>MEM 07</td><td></td></tr> </table>	ACT	1 2 4 . 3 5 0	SBY	<u>1 2 4</u> . 3 5 0	MEM 07	
ACT	1 2 4 . 3 5 0						
SBY	<u>1 2 4</u> . 3 5 0						
MEM 07							

You can now leave the user memory access by pressing **MEM** twice or by waiting for the timeout.

Alternatively, you can **add a name of up to 8 characters to the selected memory entry:**

<p>While having the memory entry selected, i.e. coming from step 4 above when adding the name to the new stored frequency, or else coming from step 3 above when adding the name to an existing memory entry:</p>	<table border="1"> <tr><td>ACT</td><td>1 2 4 . 3 5 0</td></tr> <tr><td>SBY</td><td>1 2 4 . 3 5 0</td></tr> <tr><td>MEM 07</td><td>_</td></tr> </table>	ACT	1 2 4 . 3 5 0	SBY	1 2 4 . 3 5 0	MEM 07	_
ACT	1 2 4 . 3 5 0						
SBY	1 2 4 . 3 5 0						
MEM 07	_						
5. <u>Place the cursor into the name field</u> with a long press of 							

Operation and Installation

<p>6. <u>Enter the name</u></p> <ul style="list-style-type: none"> by changing the selected character with FREQ, and advancing the selection with ▶, just as when manually entering a standby frequency. 	<pre>ACT 1 2 4 . 3 5 0 SBY 1 2 4 . 3 5 0 MEM 07 KONSTANZ</pre>
<p>7. <u>Store the name</u></p> <ul style="list-style-type: none"> either with a long press of MEM, or with a long press of ▶. 	<pre>ACT 1 2 4 . 3 5 0 SBY <u>1 2 4 . 3 5 0</u> MEM 07 KONSTANZ</pre>

You can now leave the user memory access by pressing **MEM** twice or by waiting for the timeout (12 seconds).

2.6 Dual Watch Operation

The ATR833 comprises one receiver, therefore DUAL-Watch (simultaneously monitoring two frequencies) is implemented by alternating automatically between the active and the standby frequency.

With dual watch mode active, basically the standby frequency is tuned in, shortly interrupted in regular intervals by tuning in the active frequency for a fraction of a second.

Every then detected radio signal on the active frequency has priority, and pauses the dual watch monitoring of the standby frequency, as long as the reception/transmission continues on the active frequency.

Transmissions are always done one the active frequency.

The dual watch mode is activated by pressing **DW**, and indicated by a changing the “SBY” label for the standby frequency to “DW”.

ACT	1 2 3 . 4 5 0
DW	<u>1 3 5 . 7 0 0</u>
VOL	05

The dual watch mode is deactivated by pressing **DW** again, and by any operations changing either of the frequencies.

Operation and Installation

SQL has to be set to 02 at least, as without proper squelch functionality the radio would not be able to detect whether on the active frequency a reception takes place.

In order to have an audible distinction between receptions on the active and the standby frequency, it is possible to receive the receptions from the standby frequency with a lower volume. Please refer to chapter 2.4.5 for information onto this feature “dual watch volume reduction”.

Quick approach:

- Select or enter a standby frequency which shall be additionally monitored.
- Set SQL with the **SET** key and the **VOL / SEL** rotary knob to a value of at least 02.
- Activate dual watch with **DW** (DW is shown)
- As soon as no reception is determined on the active frequency, the mutual monitoring between active and standby frequency starts.
- In order to deactivate dual watch: press **DW** once more or change the frequency.



Don't forget to interchange the active and standby frequencies, before answering a call on the standby frequency.



Using dual-watch requires switching between the active and the standby frequency. Therefore it may happen that calls on the active frequency cannot be monitored completely. As the result we recommend not to use dual-watch in airspaces where listening watch is required.

2.7 Transmission

By pushing the PTT button, the device starts transmission on the active frequency. The operation of the transmission is indicated by “TX” in front of the frequency used.

ACT TX	1 2 3 . 4 5 0
SBY	<u>1 3 5</u> . 7 0 0
VOL	05

In order to avoid unintended transmissions, e.g. when having the PTT button stuck (“stuck mic”), the transmitter automatically stops after two minutes of transmission, and „TX“ is substituted by „Te“.

In order to re-enable transmission in this case, release PTT and push it again.



When having more than one PTT button and microphone equipped, it can be configured (chapter 3.4) to use only one PTT button for transmissions.

2.8 Reception

When receiving, a „RX“ is shown in front of the active frequency. When having dual watch active (see 2.6) this can be on the standby frequency, too.

ACT RX	1 2 3 . 4 5 0
SBY	<u>1 3 5</u> . 7 0 0
VOL	05

ACT	1 2 3 . 4 5 0
DW RX	<u>1 3 5</u> . 7 0 0
VOL	05

3 CONFIGURATION

A **very long press** of **SET** (5 seconds) accesses the configuration menu. The configuration menu is used for fundamental settings.

To choose between the following settings, use the **SET** button:

1. SPC.... Channel spacing
2. CON ... Contrast
3. DPY.... Automatic display darkening
4. PTT PTT key selection
5. EXT Behavior of the external audio input
6. MLS.... Sensitivity of the left standard microphone input
7. MLD ... Sensitivity of the left dynamic microphone input
8. MRS... Sensitivity of the right standard microphone input
9. MRD... Sensitivity of the right dynamic microphone input
10. TST Activation/deactivation of the test mode (for maintenance)
- ... Leaving configuration menu / back to VOL
(can also be reached by long press of **SET**)

The chosen setting can be adjusted by the **VOL / SEL** rotary knob.

3.1 SPC – Channel Spacing

With this setting, the ATR833 can be configured to constrain frequency selection to 25 kHz channels only. This can be used to speed up the manual frequency input in areas where no 8.33 kHz channel spacing is used.

See chapter 2.5.2 on further information on manual frequency input.

ACT	1 2 3 . 4 5 0
SBY	1 1 8 . 9 1 0
SPC	8 . 33 kHz

With the **VOL / SEL** rotary knob the following options can be selected:

- 8.33 kHz Allows input of both 8.33 kHz and 25 kHz channels
- 25 kHz Allows input of 25 kHz channels only.

A short press of **SET** switches to the next configuration item, a long press of **SET** exits the configuration menu.

Operation and Installation

This configuration item is not used for determining whether a specific frequency is used with 8.33 kHz or 25 kHz channel width, as this is done by the ATR833 automatically depending onto the frequency value entered.

For more details see chapters 2.5.1 and 5.1.



Please keep in mind to enable 8.33 kHz channel selection before flying into areas where 8.33 kHz channels are used.

3.2 CON - Contrast

After pressing the **SET** key twice the contrast of the display can be adjusted with the rotary knob.

ACT	1 2 3 . 4 5 0
SBY	<u>1 1 8</u> . 9 1 0
CON	0 7

↙ Range: 01 – 10

3.3 DPY – Energy Saving Mode (Aut. Display Darkening)

In order to save energy – and to extend the lifetime of the OLED display – an **automatic display darkening** can be configured.

ACT	1 2 3 . 4 5 0
SBY	1 1 8 . 9 1 0
DPY	always on

With the **VOL/SEL** rotary knob the following options can be selected:

- always on No display darkening at all
- xx min off Automatic darkening after xx minutes of user inactivity (xx = range 1–30)

Reactivation of the darkened display is done by press of any key (except key **I/O**) or turn of any knob (the action of the key pressed is performed

Operation and Installation

when pressing the key again after the display turned on) or when transmitting.

A short press of **SET** switches to the next configuration item, a long press of **SET** exits the configuration menu.

	<p>This feature should only be used when</p> <ul style="list-style-type: none"> • it can be foreseen that no frequency changes will be required (i.e. when using only limited airspace near one airport, e.g. for circuit pattern training flights), and • the crew is familiar with the energy saving mode. <p>In all other cases this feature shall be deactivated, in order to prevent the usage of wrong frequencies and to avoid confusion of pilots not aware of the energy saving mode.</p>
---	--

3.4 PTT-Button Selection

In case of using two external PTT buttons, this configuration item can be used to deactivate one PTT button – and the associated microphone(s) – from enabling transmission.

ACT	1 2 3 . 4 5 0
SBY	1 1 8 . 9 1 0
PTT	all mics

With the **VOL / SEL** rotary knob the following options can be selected:

- | | |
|------------|--|
| all mics | Both PTT buttons and all microphones are used for transmissions, no matter what PTT button was pressed |
| single mic | According to the PTT button pressed, the associated microphone is activated |
| left only | Only the left PTT button and the left microphone(s) are used for transmissions |
| right only | Only the right PTT button and the right microphone(s) are used for transmissions |

The intercom functionality is not affected by this setting.

A short press of **SET** switches to the next configuration item, a long press of **SET** exits the configuration menu.



When deactivating one PTT button and microphone for transmissions, e.g. in order to keep passengers from interfering with ATC communication, don't forget to reactivate the copilot's PTT after end of the flight.

3.5 EXT – External Audio Input's Behavior

The external audio input can be used to feed a monaural audio signal to the amplifier for the headsets/speaker.

An external audio signal can be used for different purposes. E.g. it is possible to check the audio signal of a VOR receiver, to attach a traffic sensor with acoustic output, or to use the external audio input for (monaural) music input.

ACT	1 2 3 . 4 5 0
SBY	1 1 8 . 9 1 0
EXT	auto off

As these signals have different priorities in comparison to radio receptions, the priority of the external audio input can be configured.

With the **VOL / SEL** rotary knob the following options can be selected:

- always on The external audio input is always on, even during radio receptions and transmit mode. Use this setting only for very high priority acoustic warnings, e.g. collision warning beep tones.
- auto off The external audio input is automatically deactivated during transmit mode, or when no external audio activity is sensed.
- not RXTX The external audio input is automatically deactivated during radio receptions or transmit mode. This setting does not use the external audio activity sensing, and therefore can introduce noise when no signal source is connected.



Use this setting only when auto off does not react fast enough for very short external audio signals!

A short press of **SET** switches to the next configuration item, a long press of **SET** exits the configuration menu.

3.6 Microphone Input Sensitivity

The microphone input sensitivity is part of the configuration menu; the access to it is described in the beginning of section 3.

3.6.1 MLS – Standard Microphone Pilot/Left

3.6.2 MLD – Dynamic Microphone Pilot/Left

3.6.3 MRS – Standard Microphone Copilot/Right

3.6.4 MRD – Dynamic Microphone Copilot/Right



Every microphone input's sensitivity can be individually configured, in order to achieve equal volume with all microphones.

ACT	123.450
SBY	118.910
MLS 04	

ACT	123.450
SBY	118.910
MRS 04	

ACT	123.450
SBY	118.910
MLD 04	

ACT	123.450
SBY	118.910
MRD 04	

The following microphone inputs are available at the ATR833:

Microphone Input	Left	Right
standard (headset)	MLS	MRS
dynamic (glider's gooseneck microphone)	MLD	MRD

With **VOX** set to **5** previously, select the microphone to adjust with **SET**.

For each microphone input – if applicable: with running engine – speak with normal volume into the selected microphone, and use the **VOL / SEL** rotary knob to **adjust the sensitivity, so that the bar reaches the middle of the scale**, as depicted above.

Per microphone input a maximum of two parallel installed microphones may be connected. (see 4.6.1).

A short press of **SET** switches to the next configuration item, a long press of **SET** exits the configuration menu.



For correct microphone sensitivity configuration, VOX must be set to 5 previously (for VOX-settings refer to section 0).



Don't care for volume of the headset's/speakers output during this configuration, as this is set separately by INT.

3.7 TST – Test Mode

The last option in the setup mode is the test mode. The test mode is used by maintenance personnel only for factory-internal calibrations.

ACT	1 2 3 . 4 5 0
SBY	1 1 8 . 9 1 0
TST mode	off

The test mode is activated/deactivated with **VOL / SEL**.

With active test mode, in normal operation of the radio the lower display line contains some internal parameters, as shown below:

ACT	1 2 3 . 4 5 0
SBY	<u>1 1 8</u> . 9 1 0
VOL	03 H423 V56 E22

Any press of **SET** exits the configuration menu.

3.8 Master Reset

To reset all configurations back to factory settings, hold both the **MEM** and **▶** buttons pressed while switching the radio on with **I/O**.

Activation of the master reset is done with **DW**. After performing the reset, the confirmation „successfully“ is displayed, and the radio automatically restarts.

To leave the menu without performing a master reset, press the key **▶**.

4 INSTALLATION

4.1 Advices and Tips

The following suggestions should be considered before installing

The assigned installation company could perform wiring. For diagrams refer to section *4.7 Wiring*.

4.2 Telecommunication Data

The following data may be required when applying for the aircraft radio station license:

Manufacturer:	f.u.n.k.e. AVIONICS GmbH
Type Designation:	ATR833
EASA Number:	EASA.21O.0193
Transmitter Power Output:	6 W
Frequency:	118,000 – 136,975 MHz
Emission Designator:	6k00A3E for 25kHz channel spacing 5k00A3E for 8,33kHz channel spacing

4.3 Scope of delivery

Part Number	Description
ATR833	ATR833 – VHF communication transceiver
ZUB4	2 mounting screws and 2 hollow screws for ATR833 – for panels up to 3 mm.
SSATR2	Connector (Only if no cable set was ordered)
01.1404.010.71e	User Manual „Operation and Installation“
	EASA Form 1

4.4 Unpacking and Inspecting the Equipment

Carefully unpack the equipment. Damages due to transportation must be reported to the shipping company immediately. Save the shipping container and all packing materials to substantiate your claim



For storage or reshipment the original packaging should be used.

4.5 Mounting

- In cooperation with a maintenance shop, location and kind of the installation are specified. The maintenance shop can supply all cables. Suitable sets of cables are available from f.u.n.k.e. AVIONICS GmbH.
- Select a position away from heat sources. Care for adequate convection cooling.
- Leave sufficient space for the installation of cables and connectors.
- Avoid sharp bends and wiring close to control cables.
- Leave sufficient lead length for inspection or repair of the wiring of the connector.
- Bend the harness at the rear connectors to inhibit water droplets (formed due to condensation) from collecting in the connector.
- Remove rotary knobs (2 pieces) before mounting:
 - Lift-off faceplate with an appropriate tool
 - Loosen screw and remove rotary knob
 - Insert cap correctly orientated!
- The equipment is fixed front-laterally with two 6mm hollow screws and two 4x8mm screws in a 57 mm cut-out.
- For mounting details/drawing refer to chapter 4.11.2 Mounting Advices.

4.6 Equipment Connections

One 25 pin D-SUB miniature connector includes all electrical connections, except for the antenna.

	<p>The (+UB)-wire has to be protected by a circuit breaker (4 Amp. slow-blow)!</p>
---	--

4.6.1 Microphone-Connection

Microphone Input	Left	Right
Standard (headset)	MLS	MRS
Dynamic (glider's gooseneck microphone)	MLD	MRD

The inputs for standard microphones are appropriate for input voltages of 50 mVpp to 2 Vpp. These inputs have a bias voltage of 8 V at 330 ohms. Sensitivity is adjustable in the configuration menu (see 3.6).

The inputs for dynamic microphones are appropriate for input voltages of 5 mVpp to 10 mVpp. These inputs have no bias.

In general standard microphones (headsets) MLS/MRS and dynamic microphones (hand/gooseneck) MLD/MRD can be used simultaneously.

In motor gliders, when the engine is running, the dynamic microphones should be turned off (switch MLD/MRD inputs to GND), in order to avoid the transmission of the engine's noise.

If no dynamic microphone is installed, the input sensitivity for MLD/MRD shall be set to 1 (see 3.6).

Per input, up to two microphones can be connected in parallel.

	<p>Unused microphone inputs should be short-circuited.</p>
---	--

4.6.2 Headset-Connection

Headphones may be connected in parallel, as long as the total impedance doesn't fall below 8 Ohm.

4.6.3 Audio-Input

The external audio input can be used for the input of warn tones or music etc. In order to avoid disturbances while this input is not used, the respective wire needs to be short-circuited.

With cable sets available from f.u.n.k.e. AVIONICS GmbH the external audio-input is already short-circuited by a blind plug. This blind plug can be easily removed in order to use the external audio input.



If the external input is not used, it needs to be short-circuited with GND, in order to avoid the pickup of electrical noise.

4.6.4 Remote Control Panel

In tandem-seated aircrafts it is possible to control the ATR833 by a remote control panel (ATR600RT Remote Control Unit).



The choice of the remote control depends onto the software version of the ATR833:

Version up to SW V6.3 are remote controlled by the ATR600RT with 4-knob interface.

Versions starting from SW V6.4 on are remote controlled by the ATR600RT with 2-knob interface.

If you use a ATR600RT with 4-knob-interface, please indicate in case of repairs and software updates that no SW version larger than V6.3 may be installed!

4.7 Wiring

4.7.1 Conductor Cross Section

Power Supply (Power, GND): AWG18 (0.96 mm²)

Signals: AWG22 (0.38 mm²)

The conductors used must be approved for aircraft installation.

4.7.2 Connector – Pin Allocation

<p>SSATR2 25-pin connector at the ATR833</p> <p>View from aircraft's side</p>	MIC-R-GND	14		1	LSP(+)
	/PTT-L	15		2	HEAD(+)
	LSP(-)	16		3	HEAD(-)
	/PTT-R	17		4	EXT-NF
	MIC-R-STD	18		5	MIC-R-DYN
	MIC-L-STD	19		6	MIC-L-GND
	AUTO-ON	20		7	INTERCOM
	DATA-GND	21		8	MIC-L-DYN
	DATA-TX	22		9	DATA-RX
	LCD-LIGHT	23		10	(leave open)
	SW-12V-OUT	24		11	+12V-PWR
	GND	25		12	+12V-PWR
				13	GND

D-SUB Connector Female
seen from solder side

Pin	Names		Functionality
1	LSP(+)	LSP+	Output external Loudspeaker Positive
2	HEAD(+)	HSP+	Output Headset-Speaker Positive
3	HEAD(-)	HSP-	Output Headset-Speaker Negative
4	EXT-NF		Input external Audio-Signal
5	MIC-R-DYN	MRD+	Input dynamic Microphone (Glider/Gooseneck) Copilot/Right
6	MIC-L-GND	MLS- MLD-	Ground for Microphones Pilot/Left
7	INTERCOM	ICS	Intercom Activation Switch (connect to ground for activation of intercom)
8	MIC-L-DYN	MLD+	Input dynamic Microphone (Glider/Gooseneck) Pilot/Left

Operation and Installation

9	DATA-RX		RS232 RX (for Remote Control)
10			<i>do not connect</i>
11	+12V-PWR	+UB	Input Power Supply +12V
12	+12V-PWR	+UB	Input Power Supply +12V
13	GND	GND	Ground Side of Power Supply
14	MIC-R-GND	MRS- MRD-	Ground Microphones Copilot/Right
15	PTT-L	PTTL+	Push-to-Talk Pilot/Left (connect to ground for transmitting)
16	LSP(-)	LSP-	Output external Loudspeaker Negative (Not identical to ground!)
17	PTT-R	PTTR+	Push-to-Talk Copilot/Right (connect to ground for transmitting)
18	MIC-R-STD	MRS+	Input standard Microphone (in headset) Copilot/Right
19	MIC-L-STD	MLS+	Input standard Microphone (in headset) Pilot/Left
20	AUTO-ON	AMON	Avionic-Master-On (in aircraft with avionic master switch: may be connected to input power supply +12V to override on/off key)
21	DATA-GND		RS232 GND (for Remote Control)
22	DATA-TX		RS232 TX (for Remote Control)
23	LCD-LIGHT	LIGHT	Input LCD Illumination (in aircraft with 12V lighting bus: connect there. In all other cases: connect to input power supply +12V)
24	SW-12V- OUT		Output power supply (max 200mA for Remote Control)
25	GND	GND	Ground Side of Power Supply

4.7.3 Wiring with Cable Harness BSKS833S/BSKS833D

4.7.3.1 Overview

Cable ATR833/ATR833A

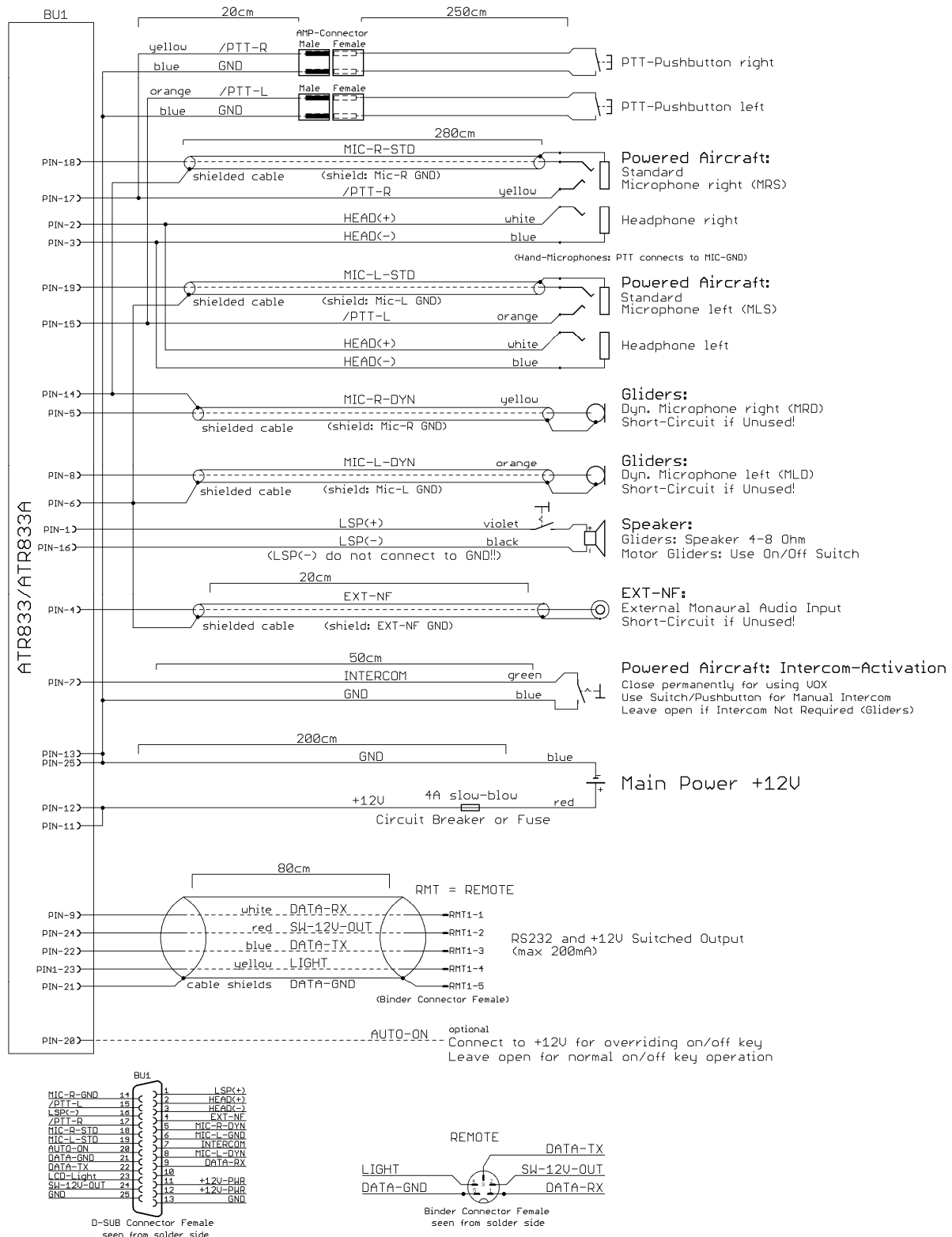

4.7.3.2 Connector RMT for Remote Control

This connector contains the serial interface and the power supplies for the remote control unit. MSTR = Master Radio

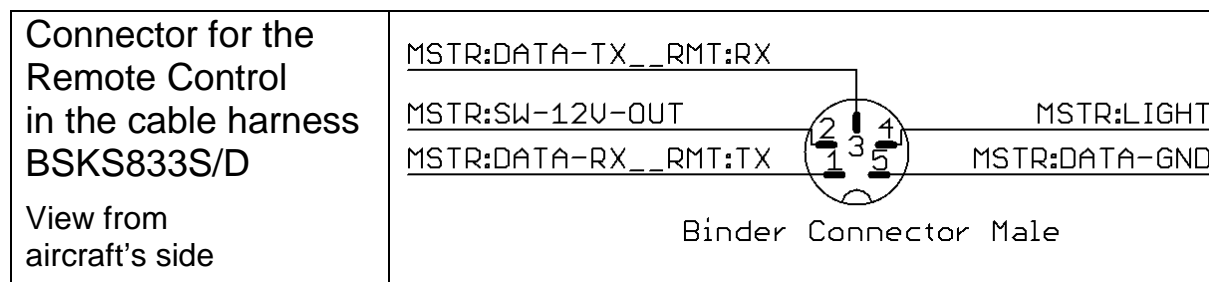

4.7.3.3 Connector EXT-NF for Monaural Audio Input

This connector is used for the input of monaural audio signals. He can be used e.g. for acoustic traffic warnings, for radio navigation receiver's acoustic identifiers, or for input of music into the headsets.

The priority of radio reception in relation to this input can be configured as described in section 3.5.

4.7.3.4 Auto-ON

Connector pin 20 determines the radio's behaviour when applying power:

To activate the radio in aircraft with a dedicated avionic master switch by this master (i.e. by applying power to the radio), connect pin 20 to the avionic master **additionally** to pins 11 and 12; in this case, the radio's on/off-key has no functionality.

In aircraft without a dedicated avionic master, pin 20 is left open; in these case, the radio's on/off-key is used.

4.8 Antenna

4.8.1 Antenna Selection

- A VHF-COM-Antenna with an impedance of 50 Ohm is required.
- Choose an antenna type approved for the aircraft and the mounting location.
- The antenna should be located far away from ELT-antennas and other VHF antennas.
- Specified features depend on proper installation of the antenna.

4.8.2 Antenna Cable

The antenna is connected by a 50 Ohm coaxial cable. The connection to the radio requires a male BNC connector.



The cable length, the attenuation of the selected cable and the quality of the connections has a direct effect on the transmitted power at the antenna. For support please contact your maintenance organization.

4.8.3 Installation Recommendation

- Take note of the antenna manufacturer's instructions.
- The metallic contact between airplane surface and antenna-GND must be very good. On non-metallic airplanes a metal foil (min. 80 cm x 80 cm) shall be used as electrical counterweight on the inside of the belly.
- To avoid a mutual interference of the radios, the antenna isolation between a voice transmission and a navigation antenna as well as between double COM antennas should be as large as possible. A distance of 2 meters usually is sufficient.

Operation and Installation

- Assemble the antenna in vertical position so on or under the belly that it is as far distant as possible from all protruding parts (propeller, chassis, vertical stabilizer)
- For glider installation the internal antenna installed by the manufacturer should be used.
- The SWR shall not exceed 3:1.



The HF antenna wire must not be included in any other cable sets, for example power supply or microphone. It must also not be placed together with other antenna wires, for example NAV or Transponder.

4.9 Microphone / Intercom settings

The settings of MIC and VOX values are essential for Intercom. The respective configuration options are described in sections 3.6 (MIC=Microphone level) and 2.4.4 (VOX=threshold level)

If the VOX automatism is deactivated with VOX=01 intercom is activated using the intercom switch (not PTT), which connects PIN 7 (intercom) of the equipment connector to GND.

For operation with VOX activated PIN 7 has to be connected to GND permanently.

Transmission merely operates when PTT is pressed.

The suppression of background noise is only possible using differential microphones, as they are usual with modern headsets. Normal electret microphones are not suitable.

4.10 Post-Installation Check

	<p>A certified maintenance shop must verify proper operation of the VHF Transceiver System.</p>
---	---

When installation is completed all steering and control functions of the aircraft are to be examined, in order to exclude disturbances by the wiring.

The SWR shall not exceed 3:1.

Furthermore a test flight is recommended, in order to guarantee the proper in-flight operation of the radio:

- In a flight altitude of at least 2000 ft contact a ground station in a distance of at least 50 km (30 nautical miles).
- Pay attention to unusual electrical interference.
- If possible, perform the radio test on frequencies within the upper and lower VHF communication frequency range

4.11 Drawings

4.11.1 Dimensions

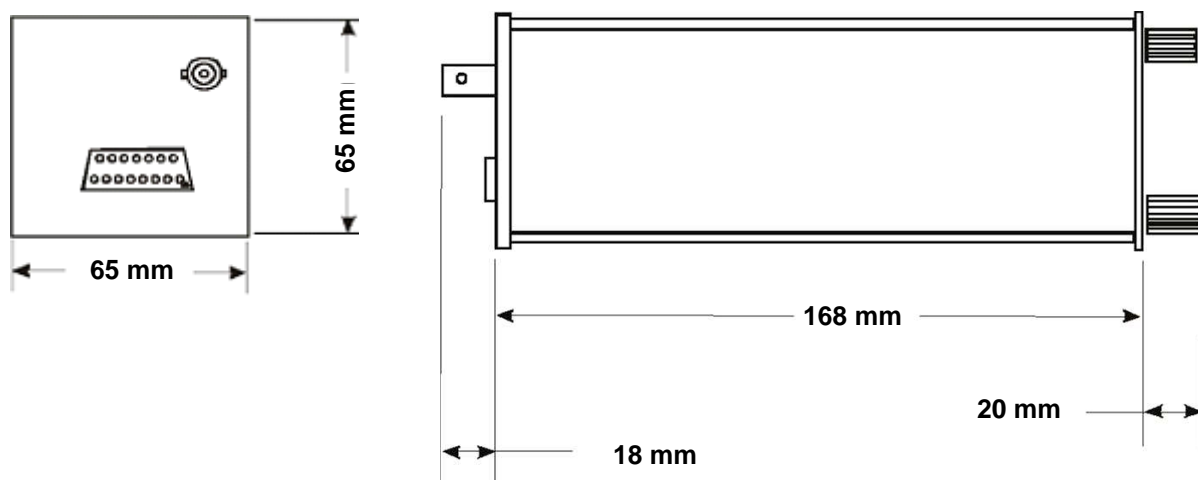



Operation and Installation

4.11.2 Mounting Advices

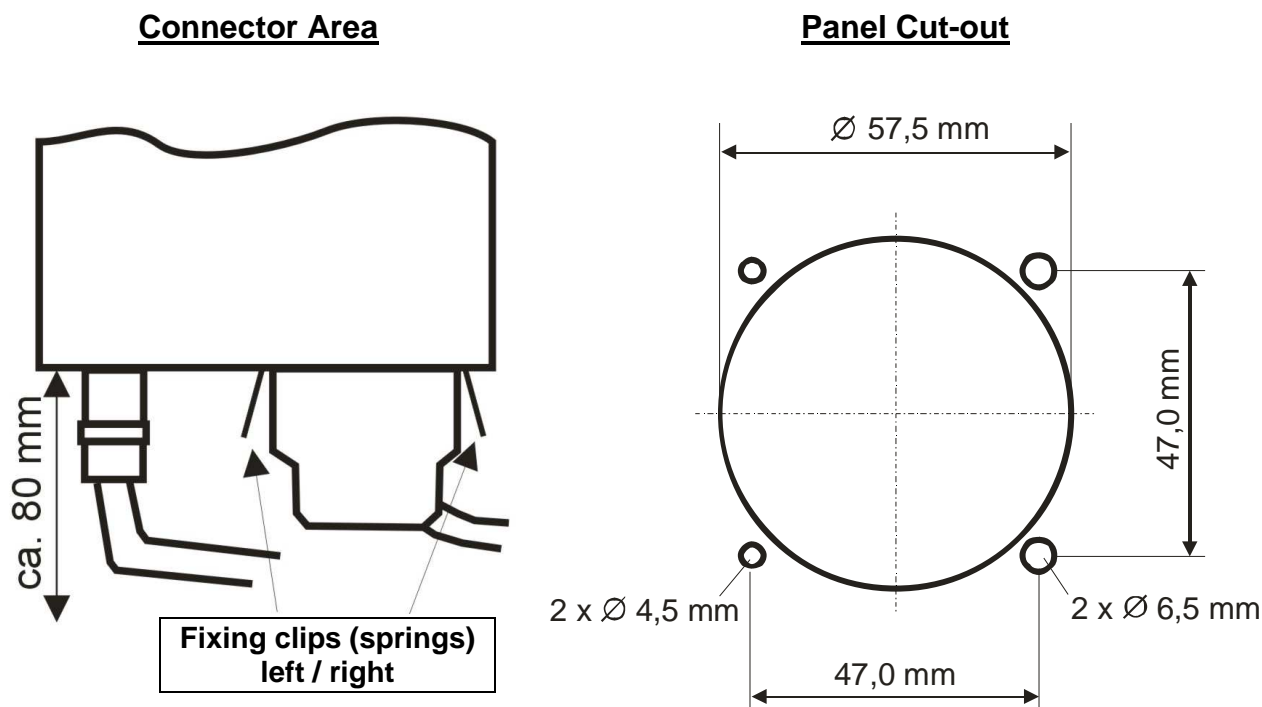
For mounting in panel with a thickness of 3-5 mm longer screws are available (Order-No. ZUB5).



	<p>No screws may be turned in more than max. 15mm into the device – even if no hard limit is noticeable!</p>
---	--

	<p>The D-Sub-Connector (plug) has to be clamped with both spring locks. It is recommended to additionally secure them with a cable tie.</p>
---	---

5 APPENDIX

5.1 Frequency/Channel-Plan

In the following table examples for operating and displayed frequencies in the range between 118.000 ... 118.100 MHz are given. This table can be continued to 136.975 MHz following the same scheme.

Operating Frequency (MHz)	Channel Width (kHz)	Displayed Frequency in 8.33/25 kHz Mode	Displayed Frequency in 25 kHz Mode
118.0000	25	118.000	118.000
118.0000	8.33	118.005	
118.0083	8.33	118.010	
118.0166	8.33	118.015	
118.0250	25	118.025	118.025
118.0250	8.33	118.030	
118.0333	8.33	118.035	
118.0416	8.33	118.040	
118.0500	25	118.050	118.050
118.0500	8.33	118.055	
118.0583	8.33	118.060	
118.0666	8.33	118.065	
118.0750	25	118.075	118.075
118.0750	8.33	118.080	
118.0833	8.33	118.085	
118.0916	8.33	118.090	
118.1000	25	118.100	118.100
118.1000	8.33	118.105	
etc.	etc.	etc.	etc.

5.2 Technical Data

GENERAL		
COMPLIANCE	ETSO-2C37e,ED-23B Class 4, 6 ETSO-2C38e,ED-23B Class C, E	
STANDARD	TSO-C37d, RTCA DO-186A Class 4, 6 TSO-C38d, RTCA DO-186A Class C, E	
DIMENSIONS	Height: 65 mm (2.56 in) Width: 65 mm (2.56 in) Length: 248 mm (9.76 in) behind the panel (incl. connector)	
WEIGHT	from P/N 833-(300)-(300)	from P/N 833-(301)-(310)
	1,32 lbs (0,6 kg)	1,15 lbs (0,52 kg)
MOUNTING	Panel Mounted	
TEMPERATURE RANGES OPERATION STORAGE	-20 °C ... +55 °C, 30 min at +70 °C -55 °C .. +85 °C	
MAX. HEIGHT	50000ft	
VIBRATION	DO-160D, Cat. S, Vibration Curve M	
HUMIDITY	RTCA DO-160D, Cat. A	
SHOCK	6 G operation 20 G crash safety	
RTCA DO-160D ENV.CAT.	[C1Z]CAA[SM]XXXXXXXXZBAAA[YY]M[B3F3]XXA	
POWER SUPPLY	13.8 VDC (11 VDC ... 18 VDC) transmitter: 2.5A receiver: 0.2A (Standby),max. 0.5A audio power amplifier: up to 1A emergency ops, reduced transmitting power < 11 VDC	
POWER CONSUMPTION	Standby: 2.8W, transmitting 35W	
FUSE	external fuse required: 4 A, slow-blow	
FREQUENCY RANGE	118.000 MHz .. 136.975 MHz	
FREQUENCY STABILITY	±30 ppm at -20 °C .. + 55 °C	
COMPASS-SAFE DISTANCE	30cm	
INTERCOM-INPUT	The microphone inputs are connected to the Intercom input. 100 mVRMS at the microphone input produce 0,5 W output power at the Headphone output (300 Ω).	
NF (AUDIO) - INPUT	1V/600Ω	

TRANSMITTER	
POWER OUTPUT	6 W (nominal) 4 W (minimal)
HARMONIC DISTORTION	< 10 % bei 70 % modulation
SIDETONE OUTPUT	>0.5W into 300Ω (per headphone)
MICROPHONE INPUTS	2 x standard (50mV...2V) into 100Ω 2 x dynamic microphone
HARMONIC CONTENT	>60dBc
MODULATION FIDELITY	deviation <6dB (350...2500Hz)
CARRIER NOISE LEVEL	>35dB at 70% modulation
UNWANTED FREQUENCY-MODULATION	<1kHz at m=70% / 1kHz
DUTY CYCLE	2 minutes on, 4 minutes off; automatic turn-off after 2 minutes of continuous transmit operation
RECEIVER	
SENSITIVITY	-105 dBm (>6dB S+N/N, m = 30 % / 1 kHz)
BANDWIDTH / 25 KHZ	-6-dB-bandwidth > ±8.0 kHz
BANDWIDTH / 8.33 KHZ	-6-dB- bandwidth > ±2.78 kHz
SELECTIVITY (channel spacing 25 KHZ)	-40-dB- bandwidth < ±17.0 kHz -60-dB- bandwidth < ±22.0 kHz
SELECTIVITY (channel spacing 8.33 KHZ)	-60-dB- bandwidth < ±7.37 kHz
SPEAKER-OUTPUT	≥4 W into 4 Ω (speaker output)
AGC CHARACTERISTICS	AF output deviation < 6 dB from 10 μV to 10 mV
SQUELCH	Automatic Squelch (adjustable)
SPURIOUS RESPONSES	> 80 dB
DISTORTION (350...2500Hz)	<25% at rated power (85% / -33dBm) <10% at 10dB below rated power (70% / -33dBm)

5.3 Environmental Conditions

Characteristic DO-160D	Section	Cat	Condition
Temperature / Altitude	4.0		
Low ground survival temperature	4.5.1	C1	- 55°C
Low operating temperature	4.5.1		- 20°C
High ground survival Temperature	4.5.2		+ 85°C
High Short-time Operating Temperature	4.5.2		+ 70°C
High Operating Temperature	4.5.3		+ 55°C
In-Flight Loss of Cooling	4.5.4	Z	No auxiliary cooling required
Altitude	4.6.1	C1	35 000 ft
Temperature Variation	5.0	C	2°C change rate minimum per minute
Humidity	6.0	A	
Shock	7.0	A	6 G operational shocks 20 G Crash Safety Test Type R in all 6 directions
Vibration	8.0	S	Vibration Curve M
Explosion Proofness	9.0	X	No test required
Water Proofness	10.0	X	No test required
Fluids Susceptibilities	11.0	X	No test required
Sand and Dust	12.0	X	No test required
Fungus Resistance	13.0	X	No test required
Salt Spray	14.0	X	No test required
Magnetic Effect	15.0	Z	Less than 0,3 m Compass Safe Distance
Power Input (DC)	16.0	B	
Voltage Spike Conducted	17.0	A	
Audio Frequency Conducted Susceptibility	18.0	A	

Characteristic DO-160D	Section	Cat	Condition
Induced Signal Susceptibility	19.0	A	
Radio Frequency Susceptibility	20.0	YY	
Emission of RF Energy	21.0	M	
Lightning Induced Transient Susceptibility	22.0	B3 F3	
Lightning Direct Effects	23.0	X	No test required
Icing	24.0	X	No test required
Electrostatic Discharge (ESD)	25.0	A	

Notes:

Notes:

f.u.n.k.e.

AVIONICS GMBH

f.u.n.k.e. AVIONICS GmbH

Heinz-Strachowitz-Str. 4
DE-86807 Buchloe
Germany

phone.: +49-8241 80066 0

fax.: +49-8241 80066 99

E-mail:

service@funkeavionics.de

www.funkeavionics.de